









**SEKTION L**  
THORAX- und GEFÄSSCHIRURGIE



**SECTION L**  
THORACIC and VASCULAR SURGERY

**SECCIÓN L**  
CIRURGÍA TORÁCICA y VASCULAR

<b>Inhaltsverzeichnis Sektion L</b>	<b>Contents Section L</b>	<b>Contenido Sección L</b>		<b>Seite, Page, Página</b>
Rippenscheren	Rib Shears	Costótomos	<b>LA</b>	L.01 - L.02
Sternotomiesperrer	Sternum Retractors	Separadores para esternotomía	<b>LA</b>	L.03 - L.04
Rippensperrer	Rib Spreaders	Separadores costales	<b>LA</b>	L.05 - L.12
Rippenkonraktoren	Rib Contractors	Contractores de costillas	<b>LA</b>	L.13
Lungenspatel, Lungenhaken	Lung Spatula, Lung Retractors	Espátula y separadores para el pulmón	<b>LA</b>	L.14
Gefäßdilatoren und Ringstripper	Vascular Dilators and Ring Strippers	Dilatadores vasculares y strippers anulares	<b>LD</b>	L.15 - L.17
Krampfaderbesteck	Varicose Vein Strippers	Strippers para várices	<b>LD</b>	L.18 - L.19
Gefäßdissektoren	Vascular Dissectors	Disecadores vasculares	<b>LD</b>	L.20
Intima-Spatel	Intima Spatulas	Espátulas para la íntima	<b>LD</b>	L.21
Tourniquets, Aorta-Dilatator	Tourniquets, Aortic Dilator	Torniquetes, dilatador para aorta	<b>LD</b>	L.22 - L.23
Mikro-Gefäßclips und Anlegezangen	Micro Vessel Clips and Applying Forceps	Micro clips vasculares y pinzas para aplicar	<b>LH</b>	L.24 - L.33
Atraumatische Gefäßklemmen	Atraumatic Vascular Clamps	Pinzas vasculares atraumáticas	<b>LK</b>	L.34 - L.63
 <b>DeBakey-Zahnung</b>	 <b>DeBakey serration</b>	 <b>Bocas tipo DeBakey</b>		
Atraumatische Gefäßklemmen	Atraumatic Vascular Clamps	Pinzas vasculares atraumáticas	<b>LK</b>	L.64 - 74
 <b>Cooley-Zahnung</b>	 <b>Cooley serration</b>	 <b>Bocas tipo Cooley</b>		
Atraumatische Gefäßklemmen	Atraumatic Vascular Clamps	Pinzas vasculares atraumáticas	<b>LK</b>	L.75
Atraumatische Gefäßklemmen	Atraumatic Vascular Clamps	Pinzas vasculares atraumáticas	<b>LK</b>	L.76
 <b>Dardik-Zahnung</b>	 <b>Dardik serration</b>	 <b>Bocas tipo Dardik</b>		
Gefäßklemmen	Vascular Clamps	Pinzas vasculares	<b>LM</b>	L.77
Bronchusklemmen	Bronchus Forceps	Pinzas-clamps bronquiales	<b>LM</b>	L.78
Aurikelklemmen	Auricle Clamps	Pinzas para auricula	<b>LM</b>	L.79
Präparier- und Ligaturklemmen	Dissecting and Ligature Forceps	Pinzas de disección y ligaduras	<b>LM</b>	L.80
Herzklappenscheren	Heart Valve Scissors	Tijeras de válvula de corazón	<b>LN</b>	L.81
Setvorschläge	Set Suggestions	Proposición de Sets	<b>ZT</b>	L.82 - L.91

**Rippenscheren**  
**Rib Shears**  
**Costótomos**



**Bethune**  
**LA 120-34**    34 cm / 13½"



**LA 130-23**    23 cm / 9"



**Gluck**  
**LA 150-22**    22 cm / 8¾"

**Rippenscheren, Sternummeißel**  
**Rib Shears, Sternum Chisel**  
**Costótomos, Cincel para esternón**



**Sauerbruch**  
LA 201-26 26 cm / 10¼"



**Giertz-Stille**  
LA 220-27 27 cm / 10¾"



**Lebsche**  
LA 250-25 25 cm / 10"

## Sternotomiesperrer Sternum Retractors Separadores para esternotomía

*Maße der Blätter: Tiefe x Breite*

*Dimensions of blades: Depth x Width*

*Dimensiones de las hojas: Profundidad x Anchura*



### **Cooley - Child**

rostfrei - stainless steel - acero inoxidable

Spreizweite - spread – abertura 145 mm

Valven - blades – valvas 20 x 45 mm

**LA 300-00**

### **Cooley - Adult**

rostfrei - stainless steel - acero inoxidable

Spreizweite - spread – abertura 185 mm

Valven - blades – valvas 30 x 50 mm

**LA 310-00**

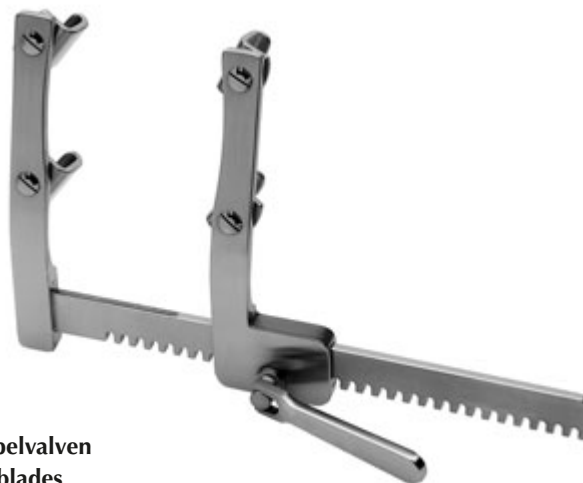

### **Morse - Child**

rostfrei - stainless steel - acero inoxidable

Spreizweite - spread – abertura 160 mm

Valven - blades – valvas 20 x 20 mm

**LA 320-00**

### **Morse - Adult**

rostfrei - stainless steel - acero inoxidable

Spreizweite - spread – abertura 200 mm

Valven - blades – valvas 20 x 28 mm

**LA 330-00**

mit beweglichen Doppelvalven  
with movable double blades  
con valvas dobles maleables

**Sternotomiesperrer**  
**Sternum Retractors**  
**Separadores para esternotomía**

*Maße der Blätter: Tiefe x Breite*

*Dimensions of blades: Depth x Width*

*Dimensiones de las hojas: Profundidad x Anchura*

**Mammaria**

rostfrei - stainless steel - acero inoxidable

Spreizweite - spread – abertura 170 mm

Valven - blades – valvas 55 x 100 mm

**LA 350-00**

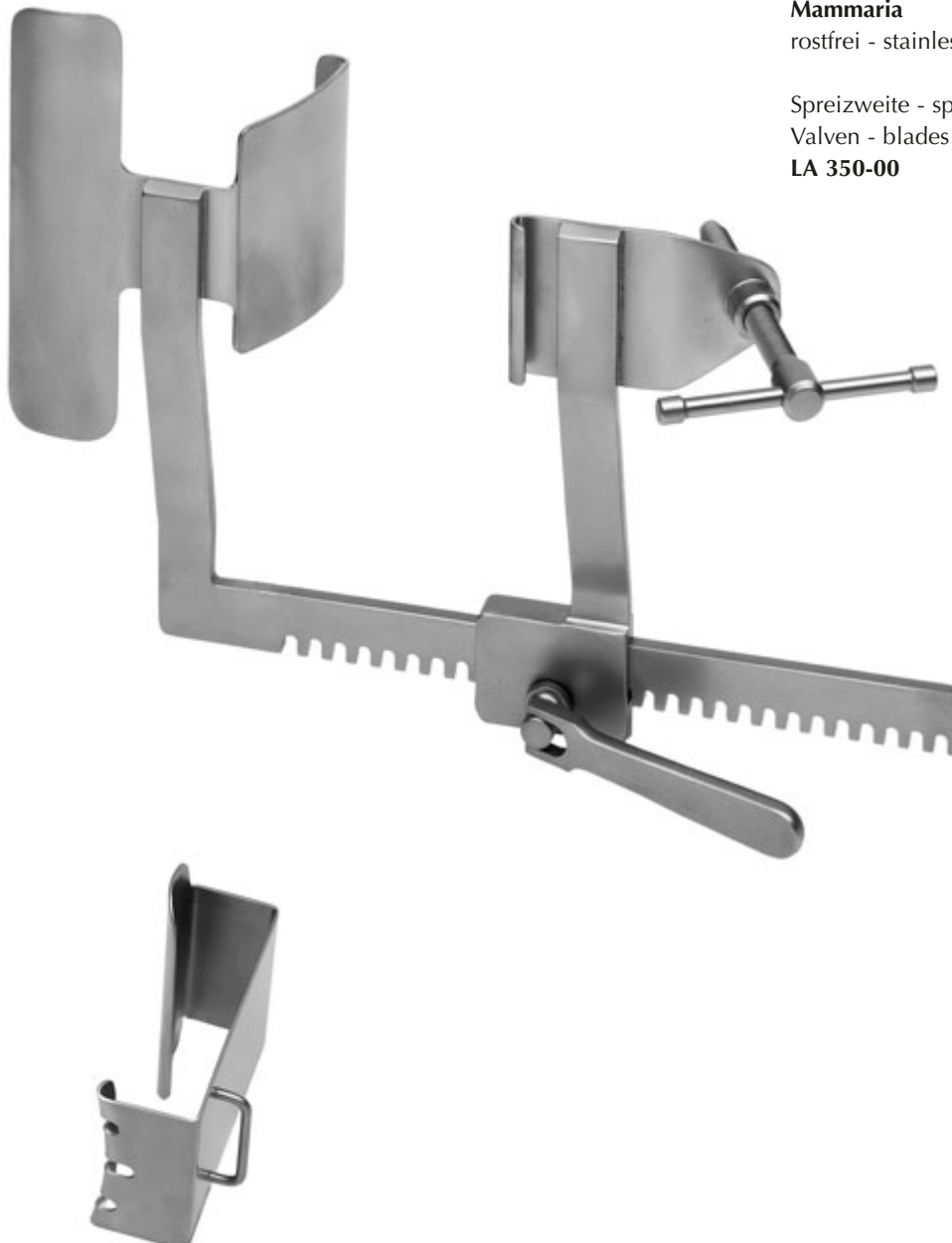

**Rippensperrer**  
**Rib Spreaders**  
**Separadores costales**

*Maße der Blätter: Tiefe x Breite*

*Dimensions of blades: Depth x Width*

*Dimensiones de las hojas: Profundidad x Anchura*



**LA 401-02**



**LA 401-03**



**Burford – Finochietto f. Child**

aus Aluminium - of aluminium - de aluminio  
komplett - complete - completo

**LA 400-13**

bestehend aus – including – compuesto de:

Sperrer - frame - cuadro

Spreizweite - spread - abertura 130 mm

**LA 401-01**

Valven - blades - valvas

2 x **LA 401-02** 30 x 42 mm

2 x **LA 401-03** 40 x 42 mm

**Burford – Finochietto f. Adult**

aus Aluminium - of aluminium - de aluminio  
komplett - complete - completo

**LA 400-16**

bestehend aus – including – compuesto de:

Sperrer - frame - cuadro

Spreizweite - spread - abertura 165 mm

**LA 401-06**

Valven - blades - valvas

2 x **LA 401-04** 45 x 62 mm

2 x **LA 401-05** 65 x 62 mm



**LA 401-04**



**LA 401-05**

**LA 400-25**

bestehend aus – including – compuesto de:

Sperrer - frame - cuadro

Spreizweite - spread - abertura 250 mm

**LA 401-07**

Valven - blades - valvas

2 x **LA 401-04** 45 x 62 mm

2 x **LA 401-05** 65 x 62 mm

**Rippensperrer**  
**Rib Spreaders**  
**Separadores costales**



*Maße der Blätter: Tiefe x Breite*

*Dimensions of blades: Depth x Width*

*Dimensiones de las hojas: Profundidad x Anchura*

**Finochietto-Baby**

aus Aluminium - of aluminium - de aluminio

Spreizweite - spread - abertura 75 mm

Valven - blades - valvas 15 x 15 mm

**LA 500-00**



**Finochietto-Baby-Haight**

aus Aluminium - of aluminium - de aluminio

Spreizweite - spread - abertura 95 mm

Valven - blades - valvas 27 x 30 mm

**LA 510-00**



**Finochietto**

aus Aluminium - of aluminium - de aluminio

Spreizweite - spread - abertura 135 mm

Valven - blades - valvas 38 x 45 mm

**LA 520-01**

Spreizweite - spread - abertura 135 mm

Valven - blades - valvas 42 x 62 mm

**LA 520-02**

Spreizweite - spread - abertura 135 mm

Valven - blades - valvas 73 x 65 mm

**LA 520-03**



**Rippensperrer**  
**Rib Spreaders**  
**Separadores costales**

*Maße der Blätter: Tiefe x Breite*

*Dimensions of blades: Depth x Width*

*Dimensiones de las hojas: Profundidad x Anchura*

**Cooley-Baby**

aus Aluminium - of aluminium - de aluminio

Spreizweite - spread - abertura 70 mm

Valven - blades - valvas 12 x 15 mm

**LA 540-01**



**Cooley-Child**

aus Aluminium - of aluminium - de aluminio

Spreizweite - spread - abertura 115 mm

Valven - blades - valvas 15 x 30 mm

**LA 540-02**

Spreizweite - spread - abertura 140 mm

Valven - blades - valvas 20 x 45 mm

**LA 540-03**

**Cooley-Adult**

aus Aluminium - of aluminium - de aluminio

Spreizweite - spread - abertura 185 mm

Valven - blades - valvas 30 x 50 mm

**LA 540-04**

**Rippensperrer**  
**Rib Spreaders**  
**Separadores costales**

*Maße der Blätter: Tiefe x Breite*

*Dimensions of blades: Depth x Width*

*Dimensiones de las hojas: Profundidad x Anchura*

**Castañeda**

aus Aluminium - of aluminium - de aluminio

Spreizweite - spread - abertura 65 mm

Valven - blades - valvas 10 x 30 mm

**LA 550-01**

Spreizweite - spread - abertura 72 mm

Valven - blades - valvas 12 x 45 mm

**LA 550-02**

Spreizweite - spread - abertura 100 mm

Valven - blades - valvas 15 x 60 mm

**LA 550-03**



## Rippensperrer Rib Spreaders Separadores costales

*Maße der Blätter: Tiefe x Breite*

*Dimensions of blades: Depth x Width*

*Dimensiones de las hojas: Profundidad x Anchura*



### **Tuffier**

rostfrei - stainless steel - acero inoxidable

Spreizweite - spread - abertura 170 mm

Valven - blades - valvas 42 x 45 mm

**LA 590-00**



### **Finochietto-Baby-Haight**

rostfrei - stainless steel - acero inoxidable

Spreizweite - spread - abertura 100 mm

Valven - blades - valvas 28 x 30 mm

**LA 600-00**



### **Finochietto - Infant**

rostfrei - stainless steel - acero inoxidable

Spreizweite - spread - abertura 70 mm

Valven - blades - valvas 12 x 15 mm

**LA 610-00**

**Rippensperrer**  
**Rib Spreaders**  
**Separadores costales**

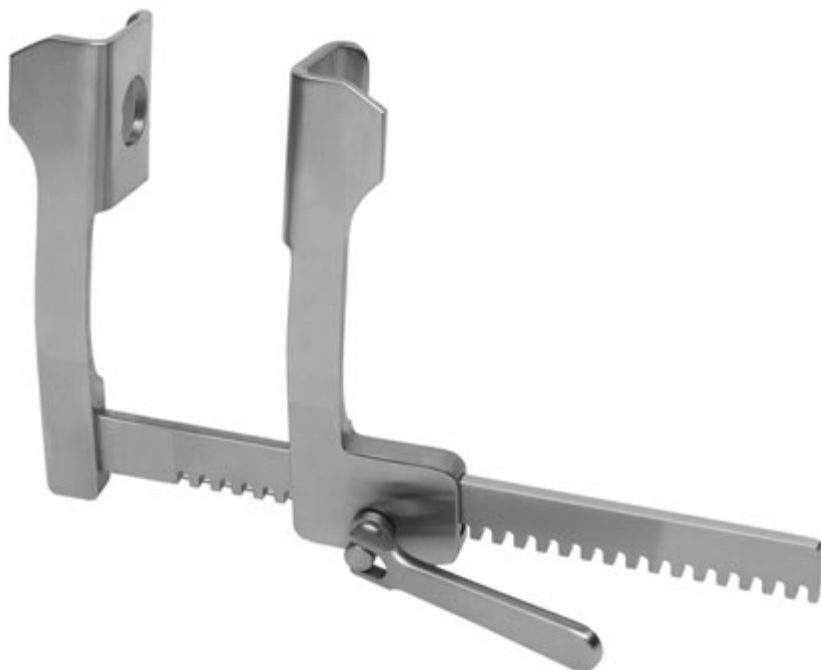

*Maße der Blätter: Tiefe x Breite*

*Dimensions of blades: Depth x Width*

*Dimensiones de las hojas: Profundidad x Anchura*

**Finochietto**

rostfrei - stainless steel - acero inoxidable

Spreizweite - spread - abertura 140 mm

Valven - blades - valvas 30 x 45 mm

**LA 620-01**

Spreizweite - spread - abertura 185 mm

Valven - blades - valvas 42 x 62 mm

**LA 620-02**

Spreizweite - spread - abertura 185 mm

Valven - blades - valvas 73 x 65 mm

**LA 620-03**



rostfrei - stainless steel - acero inoxidable

*Klappbar – tilting - plegables*

Spreizweite - spread - abertura 65 mm

Valven - blades - valvas 10 mm x 30 mm

**LA 630-01**

Spreizweite - spread - abertura 80 mm

Valven - blades - valvas 14 mm x 45 mm

**LA 630-02**

Spreizweite - spread - abertura 90 mm

Valven - blades - valvas 18 mm x 58 mm

**LA 630-03**

**Rippensperrer**  
**Rib Spreaders**  
**Separadores costales**

*Maße der Blätter: Tiefe x Breite*

*Dimensions of blades: Depth x Width*

*Dimensiones de las hojas: Profundidad x Anchura*



**DeBakey**

rostfrei - stainless steel - acero inoxidable  
komplett - complete - completo

**LA 650-00**

bestehend aus – including – compuesto de:

Sperrer - frame - cuadro

Spreizweite - spread - abertura 175 mm

**LA 651-01**

Valve - blade - valva

2 x **LA 652-01** 30 mm x 30 mm

Valve - blade - valva

2 x **LA 652-02** 40 mm x 40 mm

Valve - blade - valva

2 x **LA 652-03** 50 mm x 50 mm



**LA 652-01**

**LA 652-02**

**LA 652-03**

**Rippensperrer**  
**Rib Spreaders**  
**Separadores costales**

*Maße der Blätter: Tiefe x Breite*

*Dimensions of blades: Depth x Width*

*Dimensiones de las hojas: Profundidad x Anchura*



**DeBaKey**

rostfrei - stainless steel - acero inoxidable  
komplett - complete - completo

**LA 670-00**

bestehend aus - including - compuesto de:

Sperrer - frame - cuadro

Spreizweite - spread - abertura 250 mm / 10"

**LA 671-01**

Valven - blades - valvas

2 x **LA 672-01** 40 mm x 100 mm

Valven - blades - valvas

2 x **LA 672-02** 50 x 80 mm

Valven - blades - valvas

2 x **LA 672-03** 60 x 80 mm



**LA 672-01**



**LA 672-02**



**LA 672-03**

**Rippenkontraktoren**  
**Rib Contractors**  
**Contractores de costillas**



**Bailey-Baby**  
**LA 760-16**      16 cm / 6¼"



**Bailey**  
**LA 760-18**      18 cm / 7"



**Bailey-Gibbon**  
**LA 770-18**      18 cm / 7"

**Lungenspatel, Lungenhaken**  
**Lung Spatula, Lung Retractors**  
**Espátula y separadores para el pulmón**



**Allison**  
**LA 800-30** 30 cm / 12"  
**LA 800-32** 32 cm / 12½"



**Semb**  
27,5 cm / 10¾"  
**LA 810-01** 18 mm  
**LA 810-02** 23 mm



**LA 810-01**



**LA 810-02**



**Gefäßdilatoren**  
**Vascular Dilators**  
**Dilatadores vasculares**



**Cooley**

biegsam - malleable - maleable  
13 cm / 5"

<b>LD 100-05</b>	ø 0,5 mm
<b>LD 100-10</b>	ø 1 mm
<b>LD 100-15</b>	ø 1,5 mm
<b>LD 100-20</b>	ø 2 mm
<b>LD 100-25</b>	ø 2,5 mm
<b>LD 100-30</b>	ø 3 mm
<b>LD 100-40</b>	ø 4 mm
<b>LD 100-50</b>	ø 5 mm



**DeBakey**

biegsam - malleable - maleable  
19 cm / 7½"

<b>LD 110-05</b>	ø 0,5 mm
<b>LD 110-10</b>	ø 1 mm
<b>LD 110-15</b>	ø 1,5 mm
<b>LD 110-20</b>	ø 2 mm
<b>LD 110-25</b>	ø 2,5 mm
<b>LD 110-30</b>	ø 3 mm
<b>LD 110-35</b>	ø 3,5 mm
<b>LD 110-40</b>	ø 4 mm
<b>LD 110-45</b>	ø 4,5 mm
<b>LD 110-50</b>	ø 5 mm
<b>LD 110-70</b>	ø 7 mm
<b>LD 110-90</b>	ø 9 mm



**DeBakey**

biegsam - malleable - maleable  
35 cm / 13¾"

<b>LD 115-05</b>	ø 0,5 mm
<b>LD 115-10</b>	ø 1 mm
<b>LD 115-15</b>	ø 1,5 mm
<b>LD 115-20</b>	ø 2 mm
<b>LD 115-25</b>	ø 2,5 mm
<b>LD 115-30</b>	ø 3 mm
<b>LD 115-35</b>	ø 3,5 mm
<b>LD 115-40</b>	ø 4 mm
<b>LD 115-45</b>	ø 4,5 mm
<b>LD 115-50</b>	ø 5 mm
<b>LD 115-70</b>	ø 7 mm
<b>LD 115-90</b>	ø 9 mm

## Gefäßdilatoren

### Vascular Dilators

### Dilatadores vasculares



#### Garrett

biegsam - malleable - maleable

14 cm / 5½"

LD 120-10	ø 1 mm
LD 120-15	ø 1,5 mm
LD 120-20	ø 2 mm
LD 120-25	ø 2,5 mm
LD 120-30	ø 3 mm
LD 120-35	ø 3,5 mm
LD 120-40	ø 4 mm
LD 120-45	ø 4,5 mm
LD 120-50	ø 5 mm

Satz zu 9 - set of 9 - juego de 9

ø 1 mm - ø 5 mm (LD 120-10 - LD 120-50)

**LD 123-00**



#### Garrett

biegsam - malleable - maleable

21 cm / 8¼"

LD 124-10	ø 1 mm
LD 124-15	ø 1,5 mm
LD 124-20	ø 2 mm
LD 124-25	ø 2,5 mm
LD 124-30	ø 3 mm
LD 124-35	ø 3,5 mm
LD 124-40	ø 4 mm
LD 124-45	ø 4,5 mm
LD 124-50	ø 5 mm

Satz zu 9 - set of 9 - juego de 9

ø 1 mm - ø 5 mm (LD 124-10 - LD 124-50)

**LD 125-00**

**Ringstripper**  
**Ring Strippers**  
**Strippers anulares**



Ringstripper  
Ring Strippers  
Strippers anulares

biegsam - malleable - maleable  
50 cm / 20"

<b>LD 200-02</b>	ø 2 mm
<b>LD 200-03</b>	ø 3 mm
<b>LD 200-04</b>	ø 4 mm
<b>LD 200-06</b>	ø 6 mm
<b>LD 200-07</b>	ø 7 mm
<b>LD 200-08</b>	ø 8,5 mm
<b>LD 200-10</b>	ø 10 mm
<b>LD 200-12</b>	ø 12 mm
<b>LD 200-14</b>	ø 14 mm



Griff für Ringstripper  
Handle for ring strippers  
Mango para strippers anulares  
**LD 205-01** 12 cm / 4¾"

**Krampfaderbesteck**  
**Varicose Vein Strippers**  
**Strippers para várices**



**Nabatoff**  
 komplett - complete - completo  
**LD 250-00**

bestehend aus - including - compuesto de:



Plastikspitze - plastic tip - punta de plástico  
**LD 251-02**



Metallspitze - metal tip - punta de metal  
**LD 251-03**    ø 3 mm



**LD 251-06**



**LD 251-09**



**LD 251-12**

Metallolive - metal olive - oliva de metal  
**LD 251-06**    ø 6 mm  
**LD 251-09**    ø 9 mm  
**LD 251-12**    ø 12 mm



Handgriff - handle - mango  
**LD 252-01**

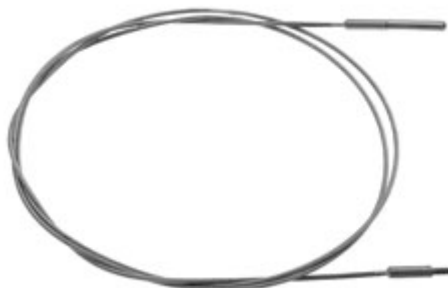

**LD 254-01**

Zugseil - traction cable - cable de tracción  
**LD 254-01**    90 cm / 35½"

Metalletui mit Deckel  
 Metal case with lid  
 Caja de metal con tapa

sterilisierbar - sterilizable - esterilizable  
**LD 256-01**

## Krampfaderbesteck Varicose Vein Strippers Strippers para várices



**Varady**  
Mini-Venenstripper Set  
**LD 260-00**

bestehend aus – including – compuesto de:



**LD 256-01**



Metallolive - metal olive - oliva de metal

**LD 261-03**    ø 3 mm

**LD 261-04**    ø 4 mm

**LD 261-05**    ø 5 mm

**LD 261-03**

**LD 261-04**

**LD 261-05**

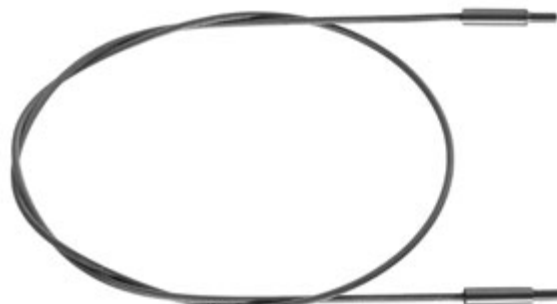

Zugseil - traction cable - cable de tracción

**LD 261-01**    45 cm / 17½"

**LD 261-01**

Metalletui mit Deckel  
Metal case with lid  
Caja de metal con tapa

sterilisierbar - sterilizable - esterilizable  
**LD 256-01**

## Gefäßdissektoren

### Vascular Dissectors

### Disecadores vasculares



#### Lemmon

leichte Biegung - light curved - curva ligera

Breite - width - anchura 3,2 mm

**LD 301-17** 17 cm / 6¾"

mittlere Biegung - medium curved - curva media

Breite - width - anchura 3,2 mm

**LD 303-17** 17 cm / 6¾"

starke Biegung - strong curved - curva fuerte

Breite - width - anchura 3,2 mm

**LD 305-17** 17 cm / 6¾"



#### Halle

leicht gebogen - light curved - curva ligera

Breite - width - anchura 3,5 mm

**LD 311-18** 18 cm / 7"



#### Schmid

leicht gebogen - light curved - curva ligera

Breite - width - anchura 5 mm

**LD 321-14** 14 cm / 5½"

leicht gebogen - light curved - curva ligera

Breite - width - anchura 7 mm

**LD 321-23** 23,5 cm / 9¼"

**Intima-Spatel**  
**Intima Spatulas**  
**Espátulas para la íntima**

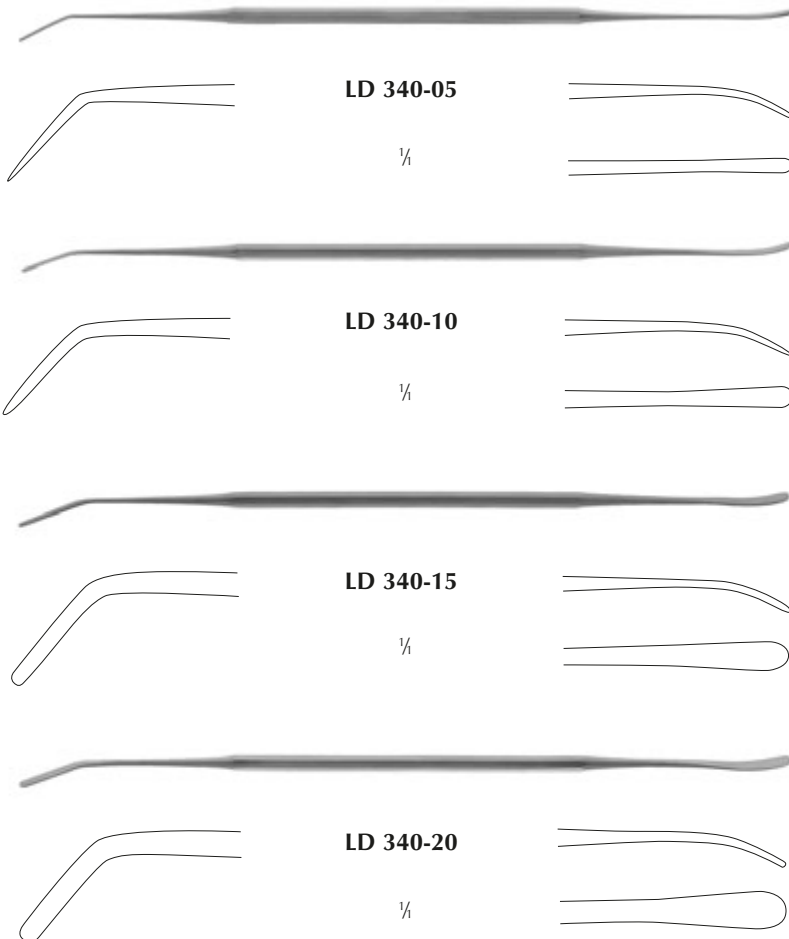

**Robb**

Länge – length - longitududa  
20,5 cm / 8"

<b>LD 340-05</b>	1,0 x 2,0 mm
<b>LD 340-10</b>	1,5 x 3,0 mm
<b>LD 340-15</b>	2,0 x 4,0 mm
<b>LD 340-20</b>	2,5 x 5,0 mm



18,5 cm / 7¼"

**LD 350-18** 3 mm



21,5 cm / 8½"

**LD 350-21** 3 mm

**Tourniquets, Mitralklappen Dilatator**  
**Tourniquets, Mitral Valve Dilator**  
**Tourniquetes, Dilatador de valva mitralis**



**Rumel-Belmont**

mit Raste – with ratchet – con cremallera  
flexibel – flexible – flexible

32 cm / 12½"

**LD 700-03**      ø 3,2 mm

**LD 700-06**      ø 6,4 mm

Ersatzstilletts

Replacement stilettes

Estiletos de recambio

28 cm / 11"

**LD 701-03**      ø 3,2 mm

**LD 701-06**      ø 6,4 mm



**Tubbs**

22 cm / 9"

Spreizweite - spread - abertura 9 mm - 45 mm

**LD 750-00**



**Mitralklappen Dilatatoren**  
**Mitral Valve Dilators**  
**Dilatadores de valva mitralis**



**Tubbs**

22 cm / 9"

Spreizweite - spread - abertura 8 mm - 42 mm

**LD 760-00**



**Cooley**

22 cm / 9"

Spreizweite - spread - abertura 6 mm - 15 mm

**LD 770-00**

Spreizweite - spread - abertura 5 mm - 18 mm

**LD 780-00**

Spreizweite - spread - abertura 6 mm - 20 mm

**LD 790-00**

**Mikro-Gefäßclips**  
**Micro Vessel Clips**  
**Micro clips vasculares**

*Alle genannten Mikro-Gefäßclips dürfen **nicht** als Implantate verwendet werden!*

*All micro vessel clips indicated **must not** be used as implants!*

*Todos los micro clips indicados **no se deben** utilizar como implantes!*



Maullänge - jaw length - longitud de boca 4 mm  
Schließdruck - jaw pressure - presión oclusiva 70 g  
Maulbreite - jaw width - anchura de boca 0,75 mm

gerade - straight - recta  
**LH 140-04**



Maullänge - jaw length - longitud de boca 6 mm  
Schließdruck - jaw pressure - presión oclusiva 70 g  
Maulbreite - jaw width - anchura de boca 0,8 mm

gerade - straight - recta  
**LH 140-06**



Maullänge - jaw length - longitud de boca 8 mm  
Schließdruck - jaw pressure - presión oclusiva 70 g  
Maulbreite - jaw width - anchura de boca 1 mm

gerade - straight - recta  
**LH 140-08**



Maullänge - jaw length - longitud de boca 10 mm  
Schließdruck - jaw pressure - presión oclusiva 70 g  
Maulbreite - jaw width - anchura de boca 1,5 mm

gerade - straight - recta  
**LH 140-10**

## Mikro-Gefäßclips und Anlegezangen Micro Vessel Clips and Applying Forceps Micro clips vasculares y pinzas para aplicar

Alle genannten Mikro-Gefäßclips dürfen **nicht** als Implantate verwendet werden!

All micro vessel clips indicated **must not** be used as implants!

Todos los micro clips indicados **no se deben** utilizar como implantes!



1/1

Maullänge - jaw length - longitud de boca 6 mm  
Schließdruck - jaw pressure - presión oclusiva 70 g  
Maulbreite - jaw width - anchura de boca 1 mm

leicht gebogen - light curve - curva ligera  
**LH 141-06**



1/1

stark gebogen - strong curve - curva fuerte  
**LH 143-06**



1/1

aufgewinkelt - angled on flat - angulada de plano 45°  
**LH 145-06**



Clip-Anlegezange, mit Sperre  
Clip applying forceps, with lock  
Pinza para aplicar clips, con cierre

gerade - straight - recta  
**LH 200-14** 14 cm / 5½"



Clip-Anlegezange, mit Sperre  
Clip applying forceps, with lock  
Pinza para aplicar clips, con cierre

bajonettförmig - bayonet-shaped - forma bayoneta  
**LH 210-18** 18,5 cm / 7¼"  
**LH 210-22** 22 cm / 8¾"

**Mikro-Gefäßclips für permanenten Verschluss**  
**Micro Vessel Clips for permanent closure**  
**Micro clips vasculares para cierre permanente**

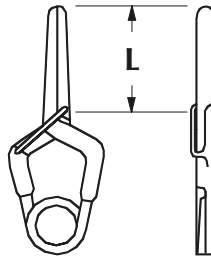

**Yasargil Standard Clip Impl. Stahl**  
**Yasargil Standard Clip Impl. Steel**  
**Yasargil Standard Clip Acero**

Maullänge L      Schließdruck  
Jaw length L      Closing force  
Largo de boca L      presión de oclusión

<b>LH 300-07</b>	7 mm	150 gr
<b>LH 300-09</b>	9 mm	180 gr
<b>LH 300-11</b>	11 mm	180 gr
<b>LH 300-15</b>	15 mm	200 gr
<b>LH 300-17</b>	17 mm	200 gr
<b>LH 300-20</b>	20 mm	200 gr
<b>LH 300-25</b>	25 mm	200 gr

**Titanium**

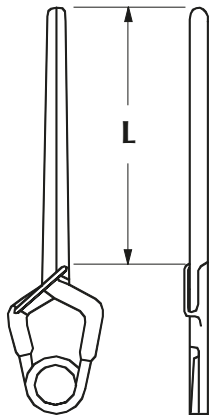

**Yasargil Standard Clip Titan**  
**Yasargil Standard Clip Titanium**  
**Yasargil Standard Clip Titanio**

Maullänge L      Schließdruck  
Jaw length L      Closing force  
Largo de boca L      presión de oclusión

<b>LH 310-07</b>	7 mm	150 gr
<b>LH 310-09</b>	9 mm	180 gr
<b>LH 310-11</b>	11 mm	180 gr
<b>LH 310-15</b>	15 mm	200 gr
<b>LH 310-17</b>	17 mm	200 gr
<b>LH 310-20</b>	20 mm	200 gr
<b>LH 310-25</b>	25 mm	200 gr

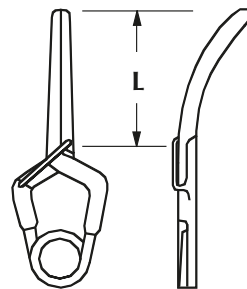

**Yasargil Standard Clip Impl. Stahl**  
**Yasargil Standard Clip Impl. Steel**  
**Yasargil Standard Clip Acero**

Maullänge L      Schließdruck  
Jaw length L      Closing force  
Largo de boca L      presión de oclusión

<b>LH 341-07</b>	7 mm	150 gr
<b>LH 341-09</b>	9 mm	180 gr
<b>LH 341-11</b>	11 mm	180 gr
<b>LH 341-15</b>	15 mm	200 gr
<b>LH 341-20</b>	20 mm	200 gr

**Mikro-Gefäßclip für permanenten Verschluss**  
**Micro Vessel Clips for permanent closure**  
**Micro clips vasculares para cierre permanente**

**Titanium**

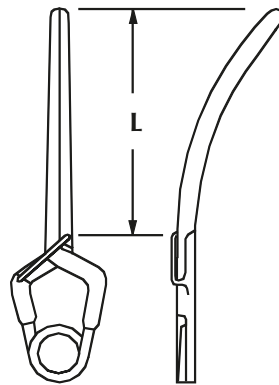

**Yasargil** Standard Clip Titan  
**Yasargil** Standard Clip Titanium  
**Yasargil** Standard Clip Titanio

Maullänge L	Schließdruck
Jaw length L	Closing force
Largo de boca L	presión de oclusión

<b>LH 351-07</b>	7 mm	150 gr
<b>LH 351-09</b>	9 mm	180 gr
<b>LH 351-11</b>	11 mm	180 gr
<b>LH 351-15</b>	15 mm	200 gr
<b>LH 351-20</b>	20 mm	200 gr

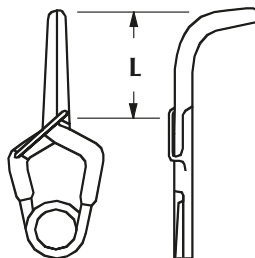

**Yasargil** Standard Clip Impl. Stahl  
**Yasargil** Standard Clip Impl. Steel  
**Yasargil** Standard Clip Acero

Maullänge L	Schließdruck
Jaw length L	Closing force
Largo de boca L	presión de oclusión

<b>LH 381-07</b>	7 mm	150 gr
<b>LH 381-09</b>	9 mm	180 gr
<b>LH 381-11</b>	11 mm	180 gr
<b>LH 381-15</b>	15 mm	200 gr
<b>LH 381-17</b>	17 mm	200 gr

**Titanium**

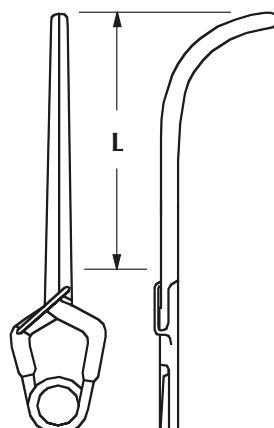

**Yasargil** Standard Clip Titan  
**Yasargil** Standard Clip Titanium  
**Yasargil** Standard Clip Titanio

Maullänge	Schließdruck
Jaw length	Closing force
Largo de boca	presión de oclusión

<b>LH 391-07</b>	7 mm	150 gr
<b>LH 391-09</b>	9 mm	180 gr
<b>LH 391-11</b>	11 mm	180 gr
<b>LH 391-15</b>	15 mm	200 gr
<b>LH 391-17</b>	17 mm	200 gr

**Mikro-Gefäßclips für permanenten Verschluss**  
**Micro Vessel Clips for permanent closure**  
**Micro clips vasculares para cierre permanente**

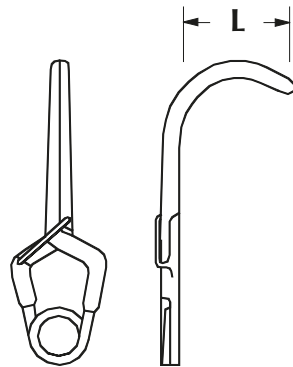

**Yasargil Standard Clip Impl. Stahl**  
**Yasargil Standard Clip Impl. Steel**  
**Yasargil Standard Clip Acero**

	Maullänge L Jaw length L Largo de boca L	Schließdruck Closing force presión de oclusión
<b>LH 421-07</b>	7 mm	180 gr
<b>LH 421-09</b>	9 mm	180 gr
<b>LH 421-11</b>	11 mm	180 gr

**Titanium**

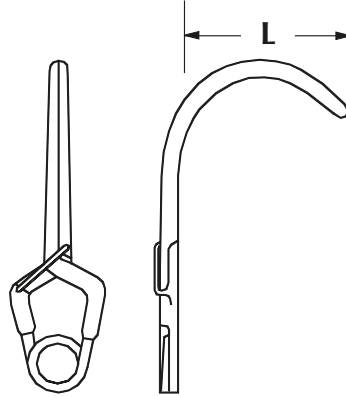

**Yasargil Standard Clip Titan**  
**Yasargil Standard Clip Titanium**  
**Yasargil Standard Clip Titanio**

	Maullänge L Jaw length L Largo de boca L	Schließdruck Closing force presión de oclusión
<b>LH 431-07</b>	7 mm	180 gr
<b>LH 431-09</b>	9 mm	180 gr
<b>LH 431-11</b>	11 mm	180 gr

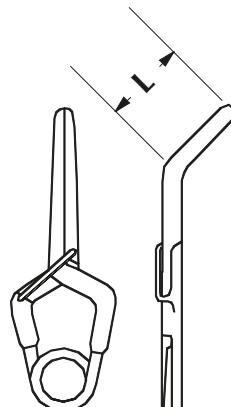

**Yasargil Standard Clip Impl. Stahl**  
**Yasargil Standard Clip Impl. Steel**  
**Yasargil Standard Clip Acero**

	Maullänge L Jaw length L Largo de boca L	Schließdruck Closing force presión de oclusión
<b>LH 461-05</b>	5 mm	200 gr
<b>LH 461-07</b>	7 mm	200 gr
<b>LH 461-09</b>	9 mm	200 gr
<b>LH 461-11</b>	11 mm	200 gr

**Mikro-Gefäßclip für permanenten Verschluss**  
**Micro Vessel Clips for permanent closure**  
**Micro clips vasculares para cierre permanente**

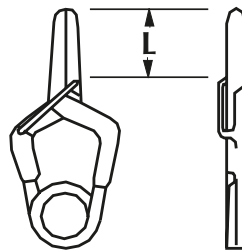

**Yasargil Mini Clip Impl. Stahl**  
**Yasargil Mini Clip Impl. Steel**  
**Yasargil Mini Clip Acero**

Maullänge L	Schließdruck
Jaw length L	Closing force
Largo de boca L	presión de oclusión

<b>LH 700-03</b>	3 mm	110 gr
<b>LH 700-05</b>	5 mm	110 gr
<b>LH 700-07</b>	7 mm	110 gr

**Titanium**

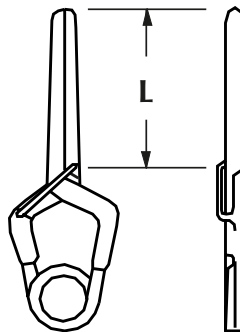

**Yasargil Mini Clip Titan**  
**Yasargil Mini Clip Titanium**  
**Yasargil Mini Clip Titanio**

Maullänge L	Schließdruck
Jaw length L	Closing force
Largo de boca L	presión de oclusión

<b>LH 710-03</b>	3 mm	110 gr
<b>LH 710-05</b>	5 mm	110 gr
<b>LH 710-07</b>	7 mm	110 gr

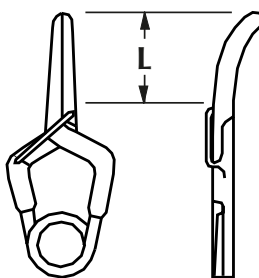

**Yasargil Mini Clip Impl. Stahl**  
**Yasargil Mini Clip Impl. Steel**  
**Yasargil Mini Clip Acero**

Maullänge L	Schließdruck
Jaw length L	Closing force
Largo de boca L	presión de oclusión

<b>LH 751-04</b>	4 mm	110 gr
<b>LH 751-05</b>	5 mm	110 gr
<b>LH 751-07</b>	7 mm	110 gr

**Titanium**

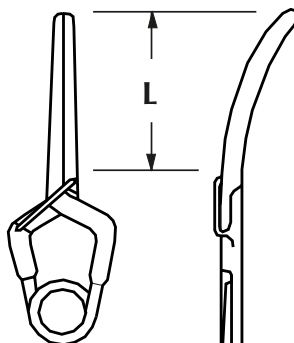

**Yasargil Mini Clip Titan**  
**Yasargil Mini Clip Titanium**  
**Yasargil Mini Clip Titanio**

Maullänge L	Schließdruck
Jaw length L	Closing force
Largo de boca L	presión de oclusión

<b>LH 781-04</b>	4 mm	110 gr
<b>LH 781-05</b>	5 mm	110 gr
<b>LH 781-07</b>	7 mm	110 gr

**Anlegezangen für Mikro-Gefäßclips**  
**Applying Forceps for Micro Vessel Clips**  
**Pinzas para poner Micro clips vasculares**

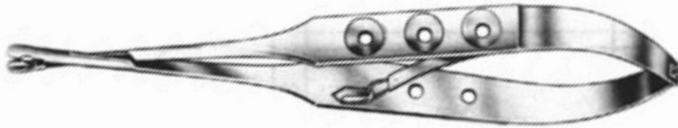

Anlegezange, gerade, mit Sperre, Länge 18 cm  
Apply Forceps, straight, with ratchet, 18 cm / 7"  
Pinza para poner, recta, con cierre, 18 cm / 7"

- LH 800-18** für Mini-Clip
- LH 810-18** für Standard-Clip

- drehbar, rotatable, giratorio
- LH 820-18** für Mini-Clip
- LH 830-18** für Standard-Clip
- LH 840-18** für Titan Mini-Clip

**Titanium**

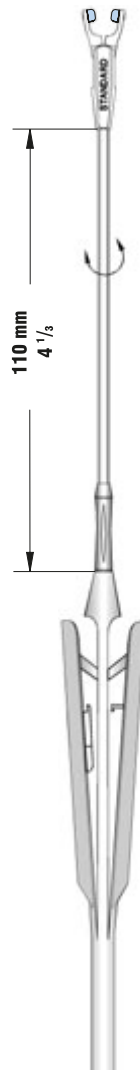

Anlegezange mit Rundgriff, flexibel  
Applying Forceps w. round handle, flexible  
Pinza para poner con mango redondo, flexible

- starr, rigid, rigido
- LH 850-01** Standard 9 cm / 3½"
- LH 850-02** Standard 11 cm / 4½"
- LH 860-01** Mini 9 cm / 3½"
- LH 860-02** Mini 11 cm / 4½"
- LH 870-01** Titan Mini 9 cm / 3½"
- LH 870-02** Titan Mini 11 cm / 4½"

- drehbar, rotatable, giratorio
- LH 880-01** Standard 9 cm / 3½"
- LH 880-02** Standard 11 cm / 4½"
- LH 890-01** Mini 9 cm / 3½"
- LH 890-02** Mini 11 cm / 4½"

Titan Ausführung  
Titanium modell  
Titanio modelo

- drehbar, rotatable, giratorio
- LH 910-01** Mini 9 cm / 3½"
- LH 910-02** Mini 11 cm / 4½"

**Titanium**

**Titanium**

**LH 880-02**



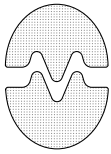

DeBakey-Zahnung  
DeBakey serration  
Bocas tipo DeBakey

## Atraumatische Bulldogklemmen und Anlegezange Atraumatic Bulldog Clamps and Applying Forceps Pinzas-bulldog atraumáticas y pinza para aplicar



### DeBakey

gerade - straight - recta

LK 050-07 7,5 cm / 3"

LK 050-08 8,5 cm / 3½"

LK 050-10 10,5 cm / 4¼"

LK 050-12 12 cm / 4¾"



1/1

LK 050-07



1/1

LK 050-08



1/1

LK 050-10



1/1

LK 050-12



1/1

LK 051-07



1/1

LK 051-08



1/1

LK 051-10



1/1

LK 051-12

### DeBakey

gebogen - curved - curva

LK 051-07 7,5cm / 3"

LK 051-08 8,5 cm / 3½"

LK 051-10 10,5 cm / 4¼"

LK 051-12 12 cm / 4¾"



### Bulldogklemmen-Anlegezange

Applying forceps for bulldog clamps

Pinza para aplicación de pinzas-bulldog

LK 061-23 23 cm / 9"

**Atraumatische Bulldogklemmen**  
**Atraumatic Bulldog Clamps**  
**Pinzas-bulldog atraumáticas**

**DeBaKey-Zahnung**  
**DeBaKey serration**  
**Bocas tipo DeBaKey**

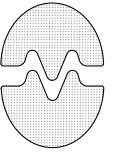

**Glover**

gerade - straight - recta

- LK 100-06** 6 cm / 2½"
- LK 100-07** 7 cm / 2¾"
- LK 100-09** 9 cm / 3½"
- LK 100-11** 11 cm / 4¼"



**LK 100-06**

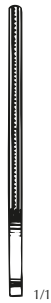

**LK 100-07**



**LK 100-09**

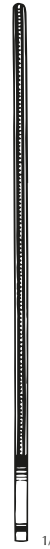

**LK 100-11**



**LK 101-06**

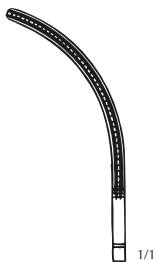

**LK 101-07**

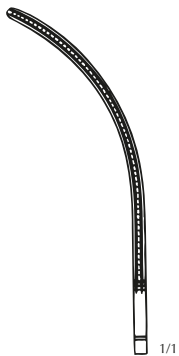

**LK 101-09**

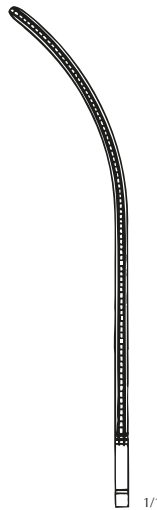

**LK 101-11**

**Glover**

gebogen - curved - curva

- LK 101-06** 6 cm / 2½"
- LK 101-07** 7 cm / 2¾"
- LK 101-09** 9 cm / 3½"
- LK 101-11** 11 cm / 4¼"

**Atraumatische Bulldogklemmen**  
**Atraumatic Bulldog Clamps**  
**Pinzas-bulldog atraumáticas**



**Mini Glover**  
gerade - straight - recta  
LK 080-35 35 mm  
LK 090-45 45 mm



gebogen - curved - curva  
LK 081-35 35 mm  
LK 091-45 45 mm

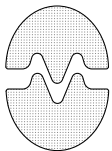

**DeBakey-Zahnung**  
**DeBakey serration**  
**Bocas tipo DeBakey**



**Carotis-DeBakey**  
LK 095-09 9 cm / 3½"



**Satinsky-DeBakey**  
LK 097-07 7 cm / 2¾"  
LK 097-10 10 cm / 4"

**Atraumatische Arterienklemmen**  
**Atraumatic Hemostatic Forceps**  
**Pinzas hemostática atraumáticas**

DeBakey-Zahnung  
DeBakey serration  
Bocas tipo DeBakey

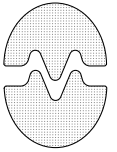

**DeBakey-Mosquito**

gerade - straight - recta

**LK 150-12** 12,5 cm / 5"

gebogen - curved - curva

**LK 151-12** 12,5 cm / 5"



**DeBakey-Kelly**

gerade - straight - recta

**LK 160-14** 14 cm / 5½"

**LK 160-16** 16 cm / 6¼"

gebogen - curved - curva

**LK 161-14** 14 cm / 5½"

**LK 161-16** 16 cm / 6¼"

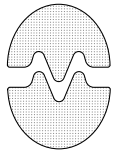

DeBakey-Zahnung  
DeBakey serration  
Bocas tipo DeBakey

**Atraumatische Arterienklemmen**  
**Atraumatic Hemostatic Forceps**  
**Pinzas hemostática atraumáticas**



**DeBakey-Pean**

gerade - straight - recta

**LK 170-16** 16 cm / 6¼"

**LK 170-18** 18 cm / 7"

**LK 170-20** 20 cm / 8"

**LK 170-26** 26 cm / 10¼"

**LK 170-28** 28 cm / 11"

gebogen - curved - curva

**LK 171-16** 16 cm / 6¼"

**LK 171-18** 18 cm / 7"

**LK 171-20** 20 cm / 8"

**LK 171-26** 26 cm / 10¼"

**LK 171-28** 28 cm / 11"



**Pean**

gerade - straight - recta

**LK 200-14** 14 cm / 5½"

gebogen - curved - curva

**LK 201-14** 14 cm / 5½"

**Atraumatische Bulldogklemmen mit Ringgriffen**  
**Atraumatic Ring-handled Bulldog Clamps**  
**Pinzas-bulldog atraumáticas con mangos anulares**

DeBakey-Zahnung  
DeBakey serration  
Bocas tipo DeBakey

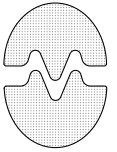

**DeBakey**  
gerade - straight - recta  
**LK 210-12** 12 cm / 4¾"



gebogen - curved - curva  
**LK 211-11** 11 cm / 4¼"



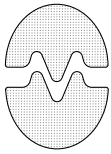

DeBailey-Zahnung  
DeBailey serration  
Bocas tipo DeBailey

## Atraumatische Bulldogklemmen mit Ringgriffen Atraumatic Ring-handled Bulldog Clamps Pinzas-bulldog atraumáticas con mangos anulares



**DeBailey**  
gebogen - curved - curva  
**LK 213-12** 12 cm / 4¾"



aufgewinkelt - angled on flat - angulada de plano  
**LK 215-10** 10 cm / 4"



aufgewinkelt - angled on flat - angulada de plano  
**LK 217-12** 12 cm / 4¾"

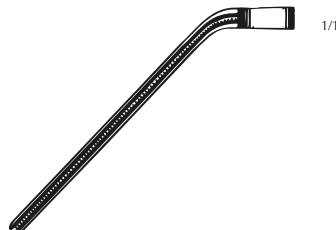

**Atraumatische Arterienklemmen**  
**Atraumatic Vascular Clamps**  
**Pinzas vasculares atraumáticas**

DeBaKey-Zahnung  
 DeBaKey serration  
 Bocas tipo DeBaKey

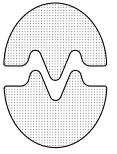

**Potts**  
 Aorta-Aneurysmaklemmen  
 Aortic aneurysm clamps  
 Pinzas para aneurisma de aorta

gerade - straight - recta  
**LK 220-21** 21 cm / 8¼"  
**LK 220-23** 23 cm / 9"  
**LK 220-27** 27 cm / 10¾"  
**LK 220-31** 31 cm / 12¼"

gebogen - curved - curva  
**LK 221-21** 21 cm / 8¼"  
**LK 221-23** 23 cm / 9"  
**LK 221-27** 27 cm / 10¾"  
**LK 221-31** 31 cm / 12¼"

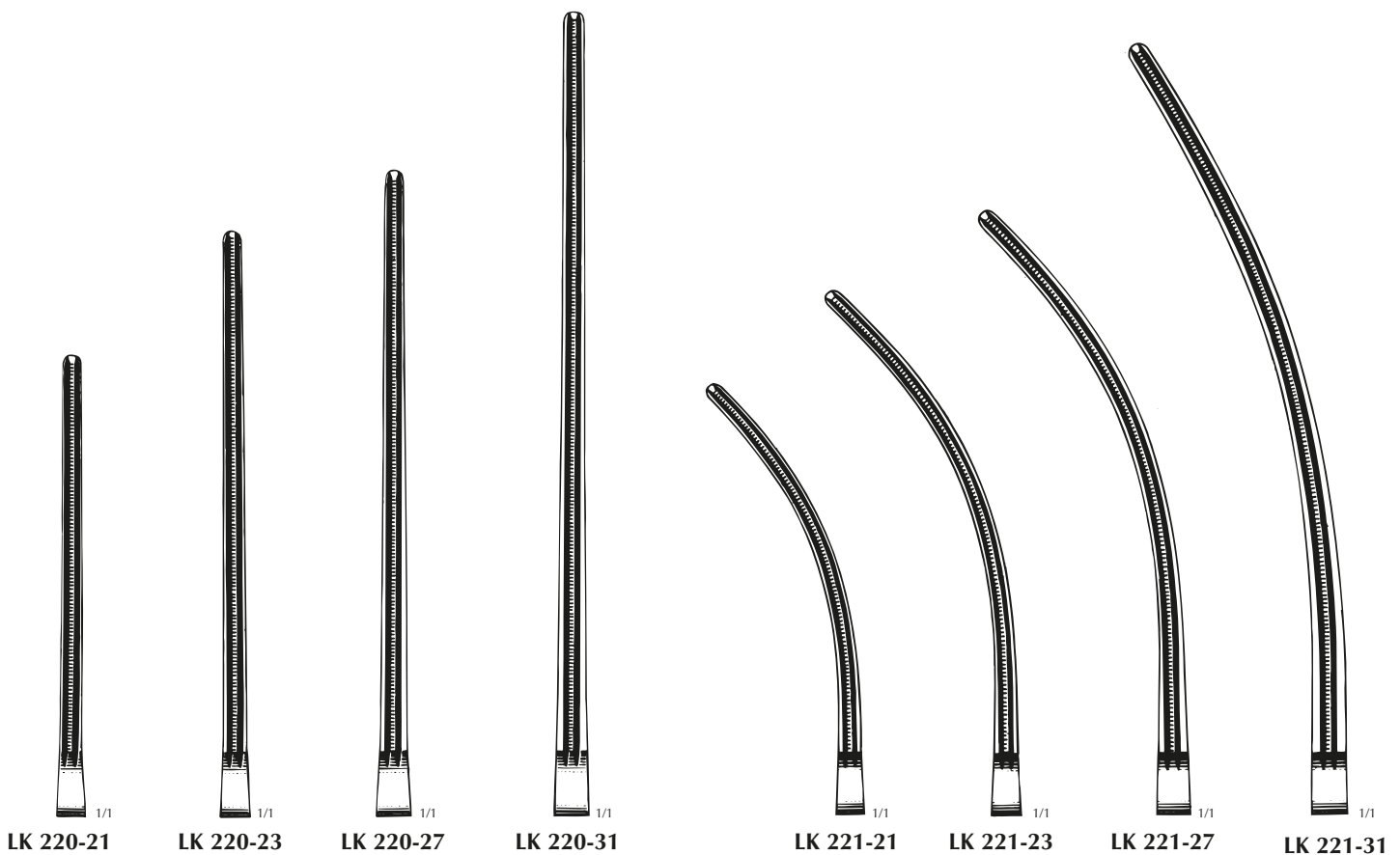



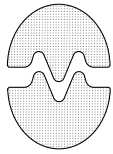

DeBakey-Zahnung  
DeBakey serration  
Bocas tipo DeBakey

**Atraumatische Arterienklemmen**  
**Atraumatic Vascular Clamps**  
**Pinzas vasculares atraumáticas**



**DeBakey**  
Aorta-Aneurysmaklemmen  
Aortic aneurysm clamps  
Pinzas para aneurisma de aorta

gebogen - curved - curva

<b>LK 231-26</b>	26 cm / 10 <sup>1</sup> / <sub>4</sub> "
<b>LK 231-27</b>	27 cm / 10 <sup>3</sup> / <sub>4</sub> "
<b>LK 231-31</b>	31 cm / 12 <sup>1</sup> / <sub>4</sub> "
<b>LK 231-33</b>	33 cm / 13"

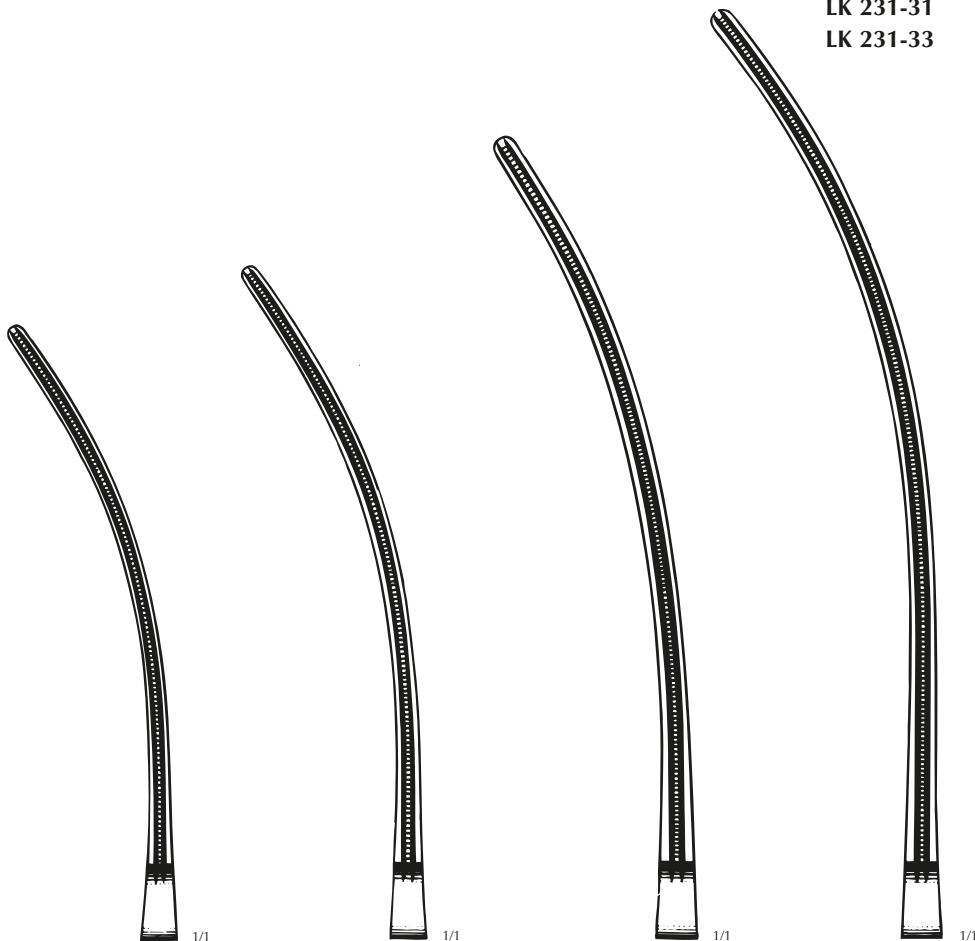

LK 231-26

LK 231-27

LK 231-31

LK 231-33

**Atraumatische Gefäßklemmen**  
**Atraumatic Vascular Clamps**  
**Pinzas vasculares atraumáticas**

DeBakey-Zahnung  
DeBakey serration  
Bocas tipo DeBakey

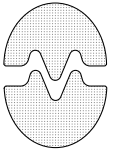

**DeBakey**  
Mehrzweckklemmen 60°  
Multi-purpose clamps 60°  
Pinzas multi-funcionales 60°  
**LK 241-21** 21 cm / 8¼"  
**LK 241-23** 23 cm / 9"  
**LK 241-26** 26 cm / 10¼"  
**LK 241-30** 30,5 cm / 12"

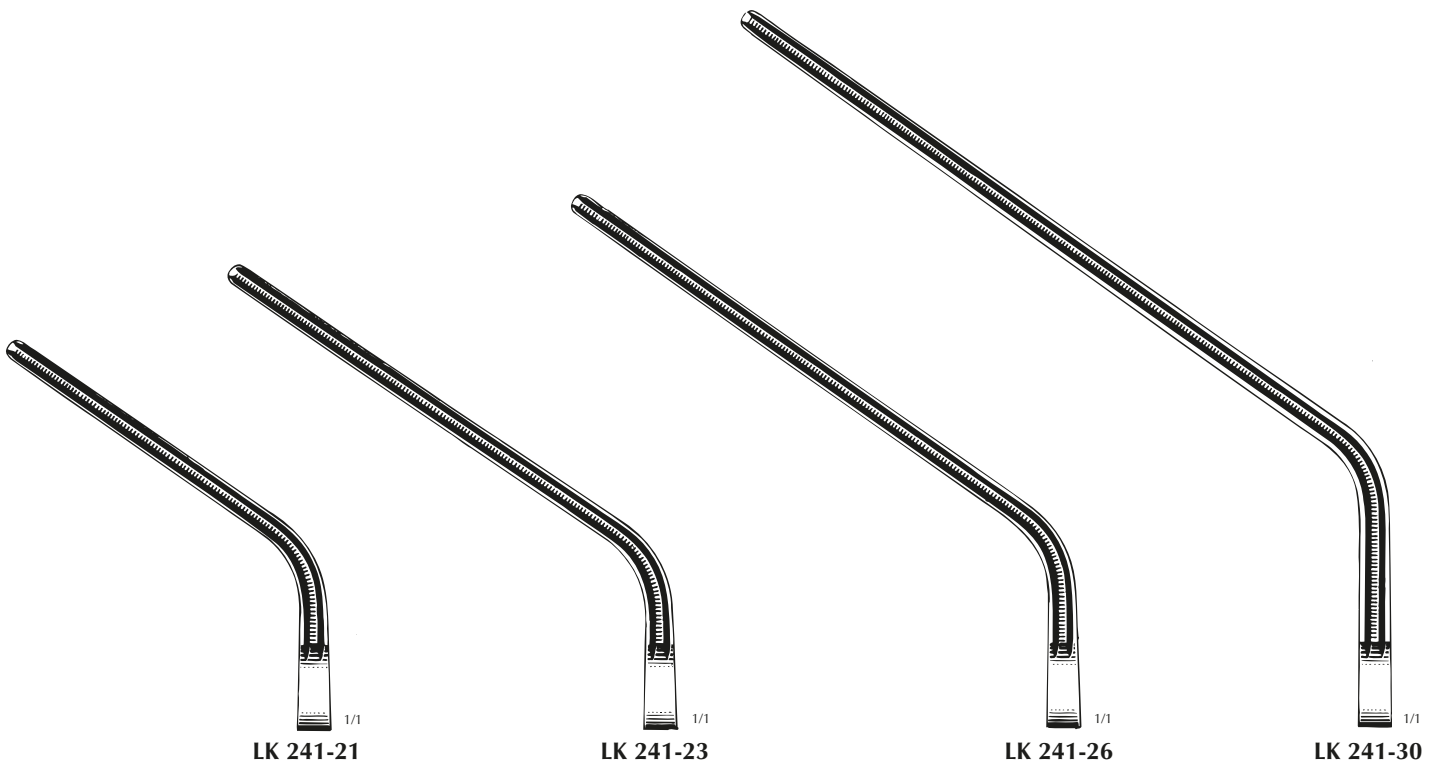

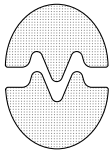

DeBailey-Zahnung  
DeBailey serration  
Bocas tipo DeBailey

**Atraumatische Gefäßklemmen**  
**Atraumatic Vascular Clamps**  
**Pinzas vasculares atraumáticas**

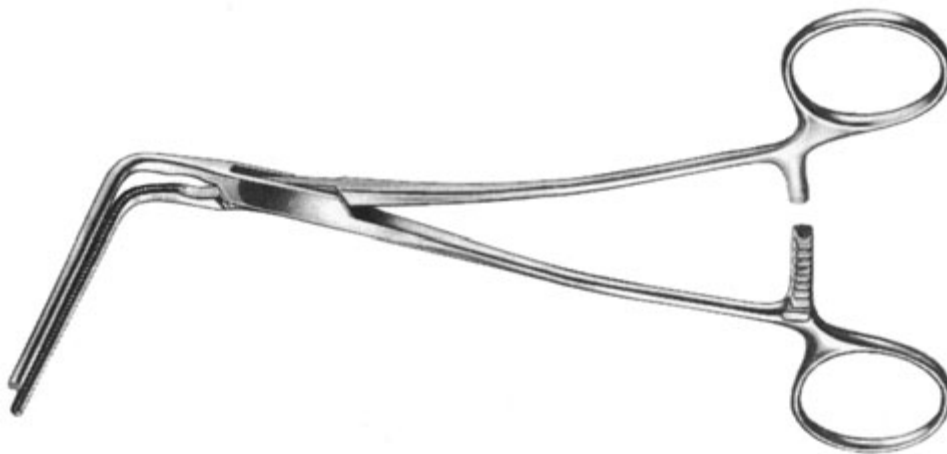

**DeBailey**

Mehrzweckklemmen 90°  
Multi-purpose clamps 90°  
Pinzas multi-funcionales 90°

<b>LK 245-18</b>	18 cm / 7"
<b>LK 245-19</b>	19 cm / 7½"
<b>LK 245-21</b>	21,5 cm / 8½"
<b>LK 245-25</b>	25,5 cm / 10"

LK 245-18 1/1

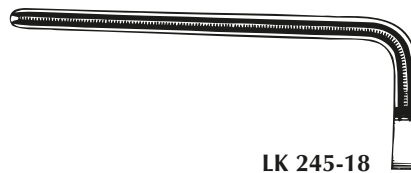

LK 245-19 1/1

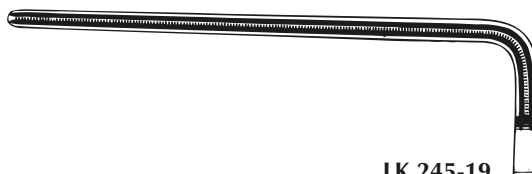

LK 245-21 1/1

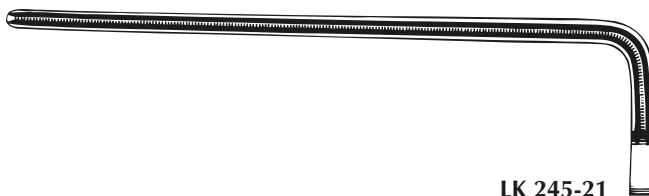

LK 245-25 1/1

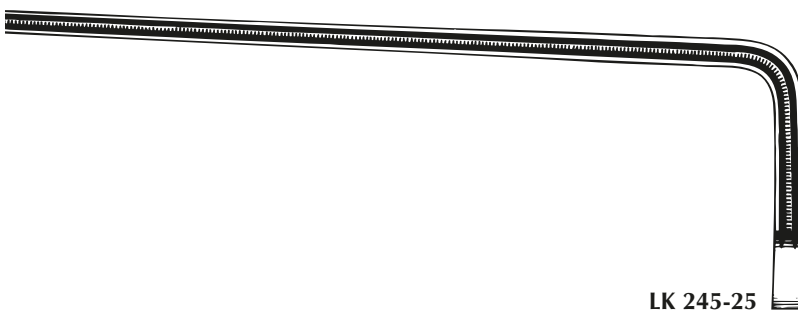

**Atraumatische Gefäßklemmen**  
**Atraumatic Vascular Clamps**  
**Pinzas vasculares atraumáticas**

DeBaKey-Zahnung  
 DeBaKey serration  
 Bocas tipo DeBaKey

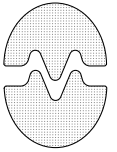

**DeBaKey-Semb**

Ligaturklemmen  
 Ligature clamps  
 Pinzas para ligaduras

**LK 251-23** 23,5 cm / 9 1/4"  
**LK 251-25** 25 cm / 10"

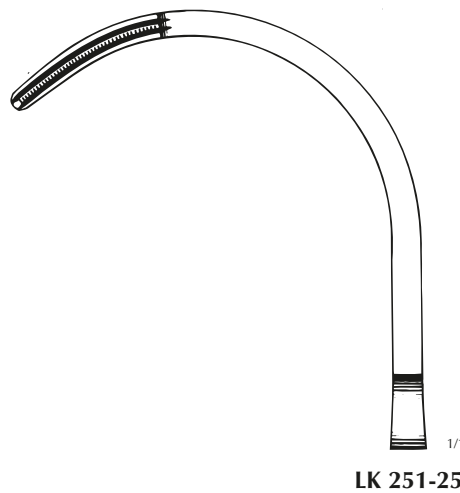
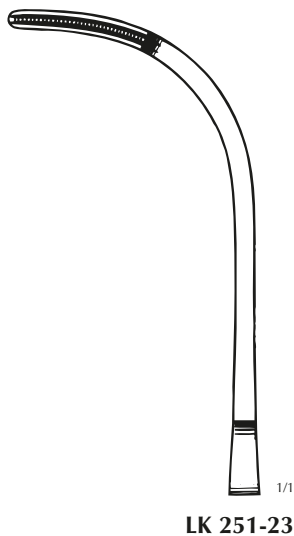

**DeBaKey**

Aortaklemmen  
 Aortic clamps  
 Pinzas para aorta

**LK 253-23** 23,5 cm / 9 1/4"  
**LK 253-25** 25 cm / 10"

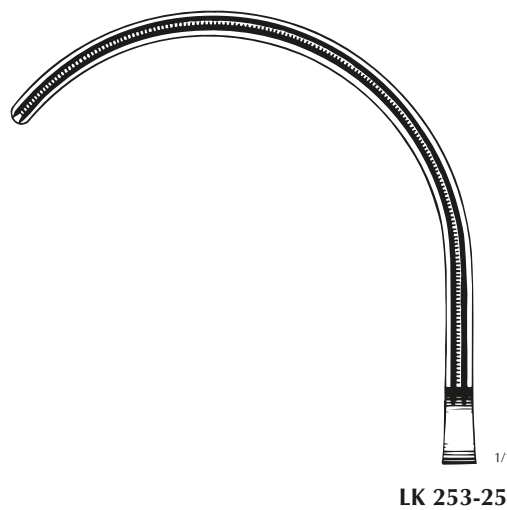
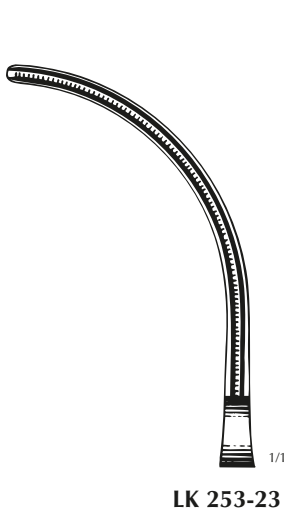

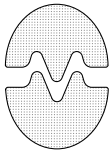

DeBailey-Zahnung  
DeBailey serration  
Bocas tipo DeBailey

**Atraumatische Gefäßklemmen**  
**Atraumatic Vascular Clamps**  
**Pinzas vasculares atraumáticas**



**DeBailey-Bahson**

Aneurysmaklemmen für die Arteria iliaca

Aneurysm clamps for the iliac artery

Para aneurisma de la arteria iliaca

**LK 261-24** 24 cm / 9½"

**LK 261-25** 25 cm / 10"

**LK 263-23** 23 cm / 9"

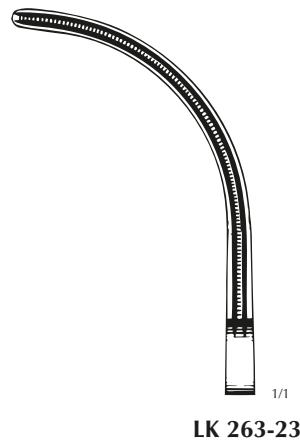
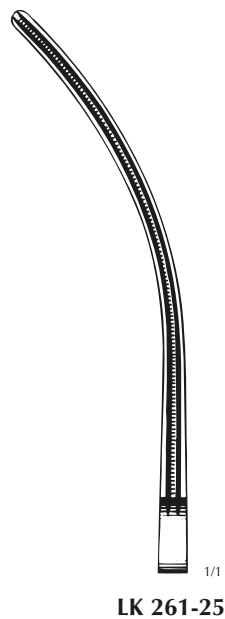
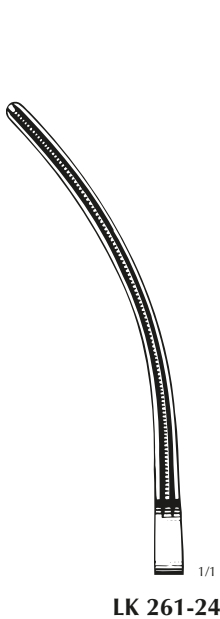

**Atraumatische Gefäßklemmen**  
**Atraumatic Vascular Clamps**  
**Pinzas vasculares atraumáticas**

DeBakey-Zahnung  
DeBakey serration  
Bocas tipo DeBakey

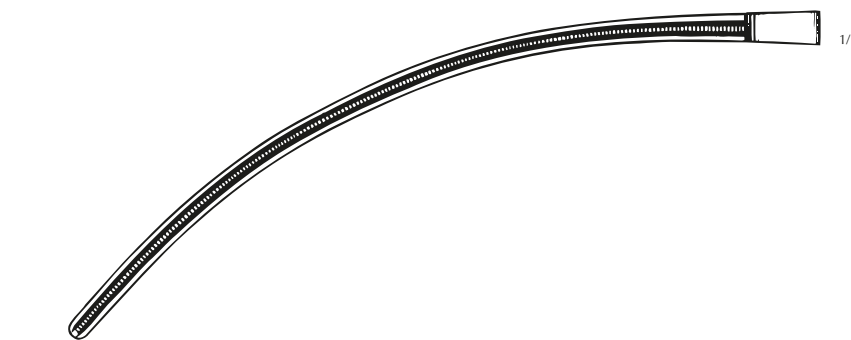
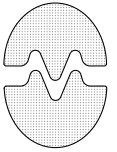

**DeBakey**  
Aorta-Aneurysmaklemme  
Aortic aneurysm clamp  
Pinza para aneurisma de aorta  
**LK 271-30** 30 cm / 12"

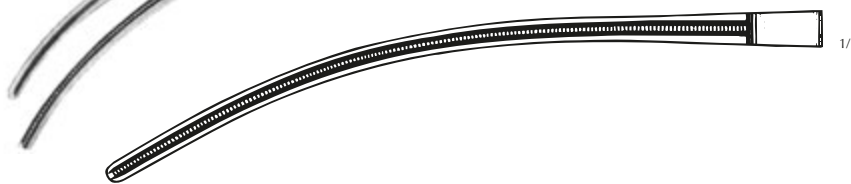
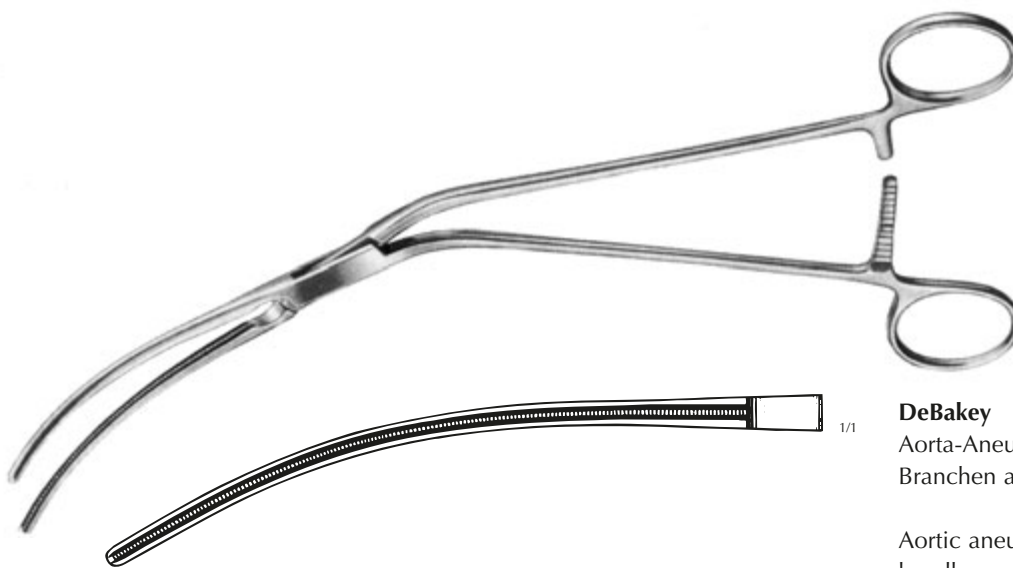

**DeBakey**  
Aorta-Aneurysmaklemme,  
Branchen aufgewinkelt

Aortic aneurysm clamp,  
handles angled on flat

Pinza para aneurisma de aorta,  
mangos angulados de plano  
**LK 285-25** 25,5 cm / 10"

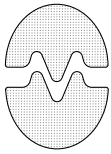

DeBakey-Zahnung  
DeBakey serration  
Bocas tipo DeBakey

**Atraumatische Gefäßklemmen**  
**Atraumatic Vascular Clamps**  
**Pinzas vasculares atraumáticas**

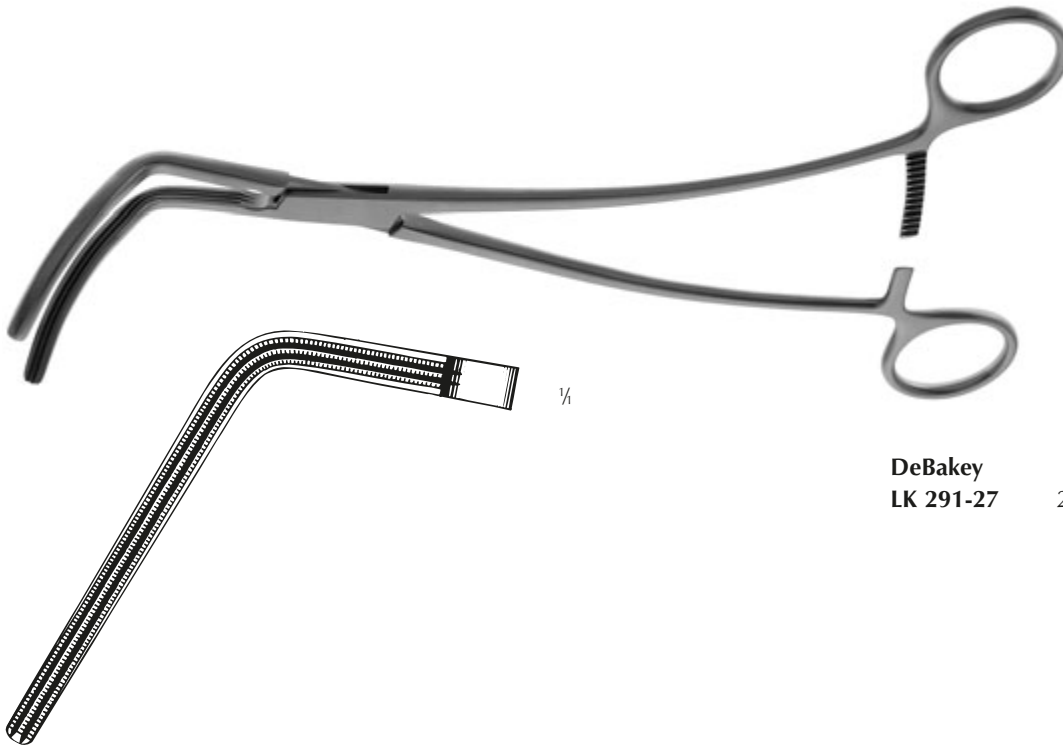

DeBakey  
LK 291-27 27 cm / 10½"

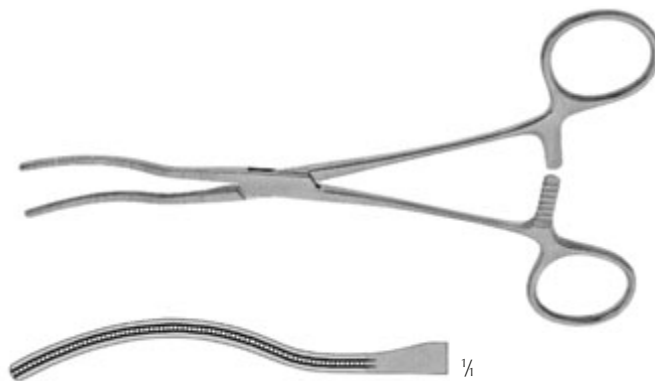

DeBakey  
LK 295-17 17 cm / 6¾"

**Atraumatische Gefäßklemmen**  
**Atraumatic Vascular Clamps**  
**Pinzas vasculares atraumáticas**

DeBakey-Zahnung  
DeBakey serration  
Bocas tipo DeBakey

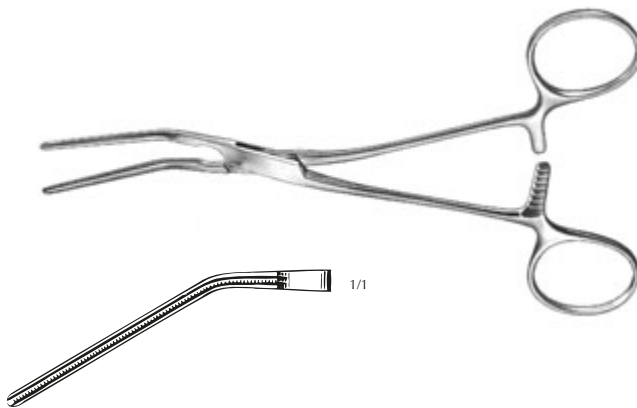
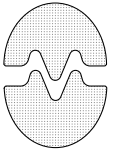

**DeBakey**  
Mehrzweckklemmen  
Multi-purpose clamps  
Pinzas multi-funcionales

aufgewinkelt - angled on flat - angulada 30°  
**LK 301-16** 16 cm / 6¼"

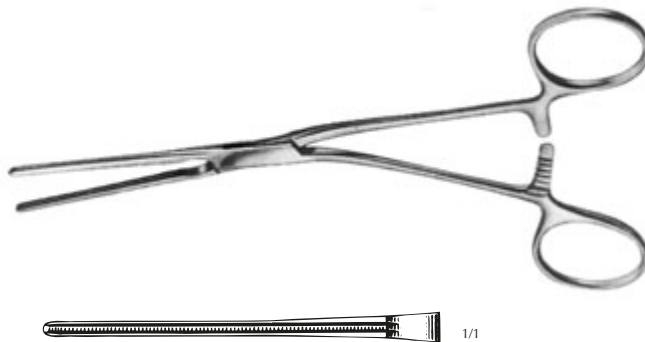

Branchen aufgewinkelt  
Handles angled on flat  
Mangos angulados de plano  
**LK 301-17** 17 cm / 6¾"



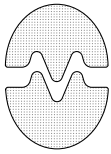

DeBakey-Zahnung  
DeBakey serration  
Bocas tipo DeBakey

## Atraumatische Gefäßklemmen Atraumatic Vascular Clamps Pinzas vasculares atraumáticas

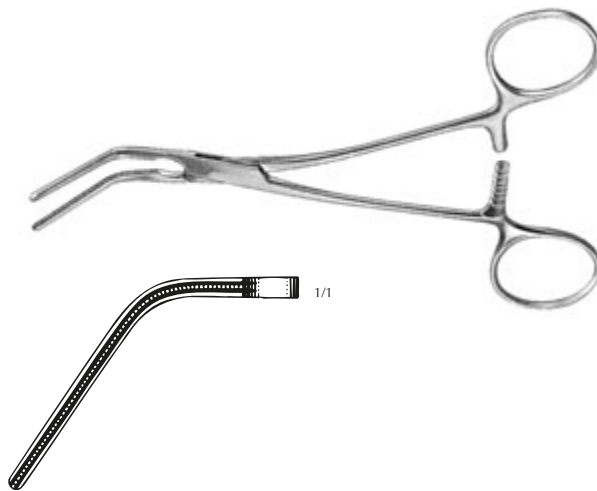

**DeBakey**  
Mehrzweckklemmen  
Multi-purpose clamps  
Pinzas multi-funcionales

aufgewinkelt - angled on flat - angulada 60°  
**LK 303-15** 15 cm / 6"



aufgewinkelt - angled on flat - angulada 90°  
**LK 305-13** 13 cm / 5"

**Atraumatische Gefäßklemmen**  
**Atraumatic Vascular Clamps**  
**Pinzas vasculares atraumáticas**

DeBakey-Zahnung  
DeBakey serration  
Bocas tipo DeBakey

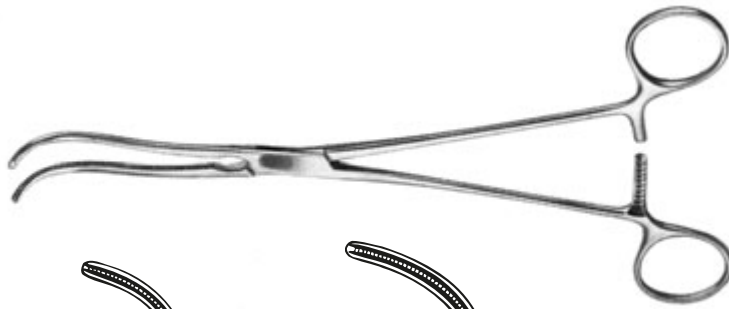
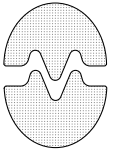

**DeBakey**  
Präparier- und Ligaturklemmen  
Dissecting and ligature clamps  
Pinzas para disección y ligaduras  
**LK 311-19** 19 cm / 7½"  
**LK 311-23** 23 cm / 9"

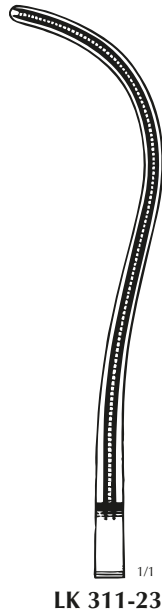
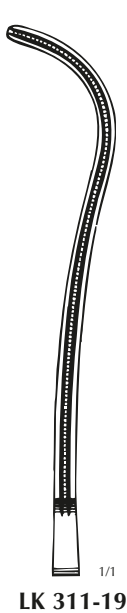

**DeBakey**  
Peripheralklemme  
Peripheral clamp  
Pinza periferica  
**LK 321-16** 16 cm / 6¼"

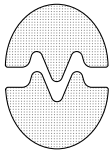

DeBailey-Zahnung  
DeBailey serration  
Bocas tipo DeBailey

## Atraumatische Gefäßklemmen Atraumatic Vascular Clamps Pinzas vasculares atraumáticas

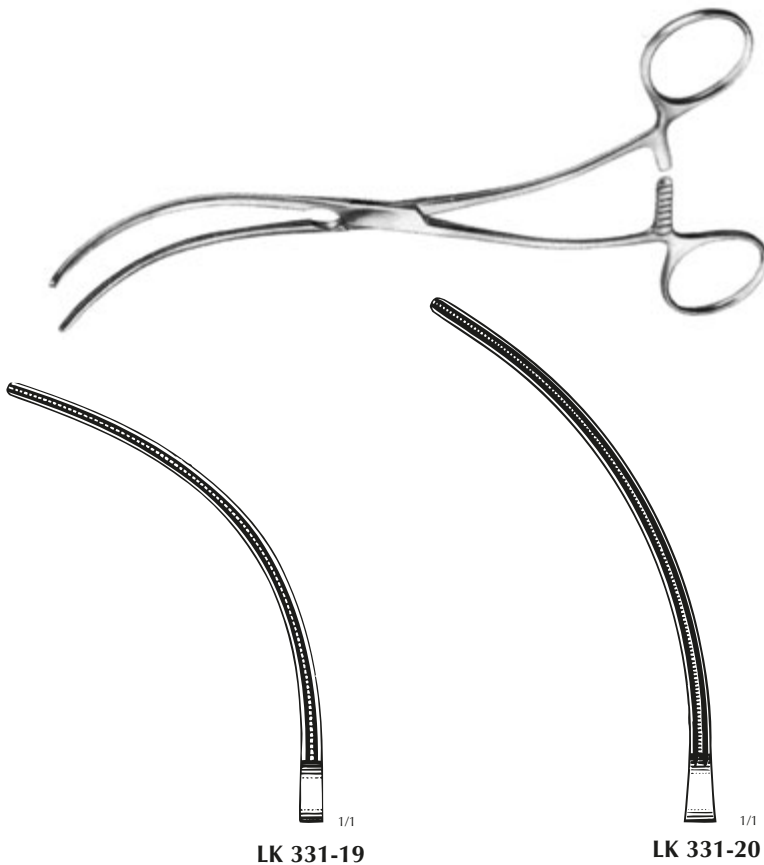

### DeBailey

Peripheralklemmen

Peripheral clamps

Pinzas perifericas

**LK 331-19** 19 cm / 7½"

**LK 331-20** 20 cm / 8"

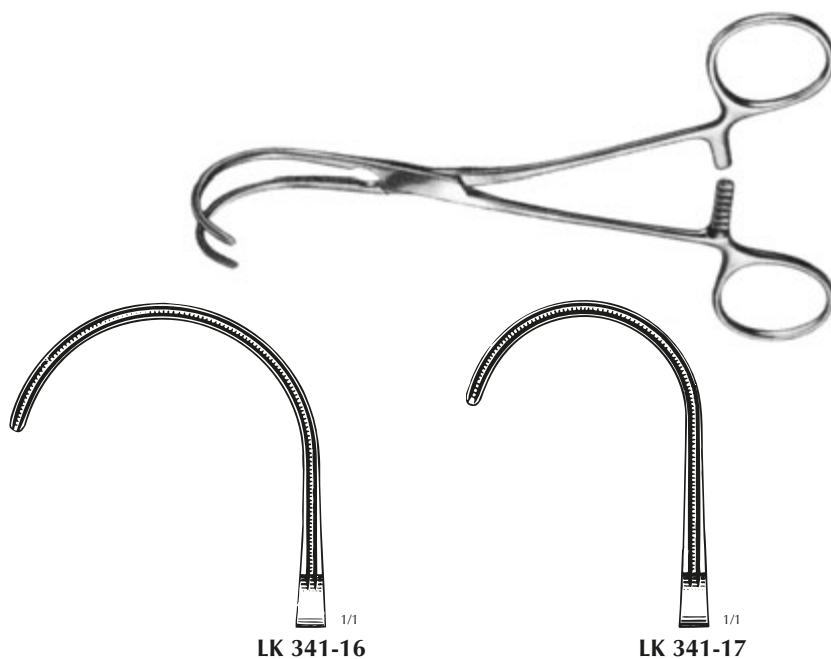

### DeBailey

Ligaturklemmen

Ligature clamps

Pinzas para ligaduras

**LK 341-16** 16 cm / 6¼"

**LK 341-17** 17 cm / 6¾"

**Atraumatische Gefäßklemmen**  
**Atraumatic Vascular Clamps**  
**Pinzas vasculares atraumáticas**

**DeBakey-Zahnung**  
**DeBakey serration**  
**Bocas tipo DeBakey**

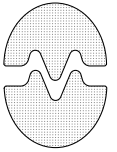

**DeBakey-Beck**

**LK 351-15** 15 cm / 6"  
**LK 353-15** 15 cm / 6"

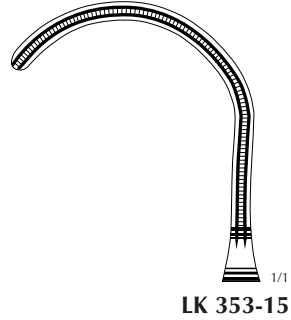
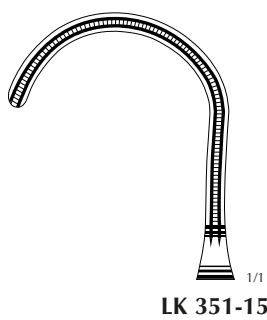

**Morris-DeBakey**

**Aortaklemmen**  
**Aortic clamps**  
**Pinzas para aorta**

**LK 411-21** 21,5 cm / 8½"  
**LK 411-25** 25 cm / 10"

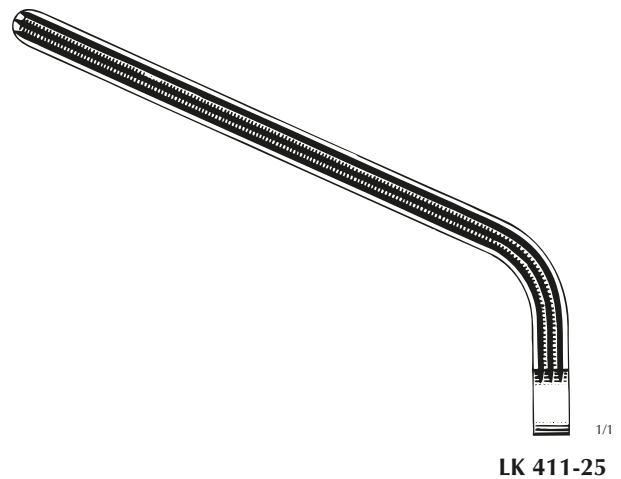
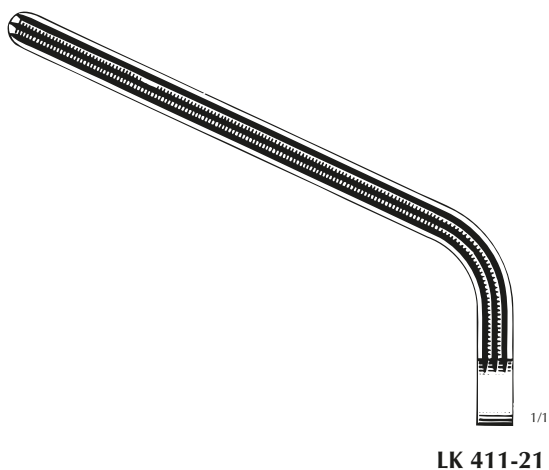

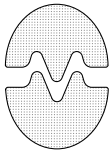

DeBakey-Zahnung  
DeBakey serration  
Bocas tipo DeBakey

**Atraumatische Gefäßklemmen**  
**Atraumatic Vascular Clamps**  
**Pinzas vasculares atraumáticas**



**DeBakey**  
Coarctation - Coarctation - Coarctación  
gerade - straight - recta  
**LK 412-17** 17 cm / 6¾"



**DeBakey**  
gerade - straight - recta  
**LK 420-16** 16,5 cm / 6½"  
**LK 420-20** 20,5 cm / 8"  
**LK 420-22** 22,5 cm / 9"  
**LK 420-26** 26 cm / 10¼"



**DeBakey**  
aufgewinkelt - angled - angulado  
**LK 421-16** 16,5 cm / 6½"  
**LK 421-20** 20,5 cm / 8"  
**LK 421-22** 22,5 cm / 9"  
**LK 421-26** 26 cm / 10¼"

**Atraumatische Gefäßklemmen**  
**Atraumatic Vascular Clamps**  
**Pinzas vasculares atraumáticas**

DeBakey-Zahnung  
 DeBakey serration  
 Bocas tipo DeBakey

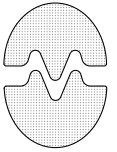

**DeBakey-Satinsky**  
 Tangentialklemmen  
 Tangential occlusion clamps  
 Pinzas para oclusión tangencial

<b>LK 451-20</b>	20,5 cm / 8"
<b>LK 451-24</b>	24 cm / 9½"
<b>LK 451-25</b>	25 cm / 10"
<b>LK 451-26</b>	26,5 cm / 10½"
<b>LK 451-27</b>	27,5 cm / 10¾"

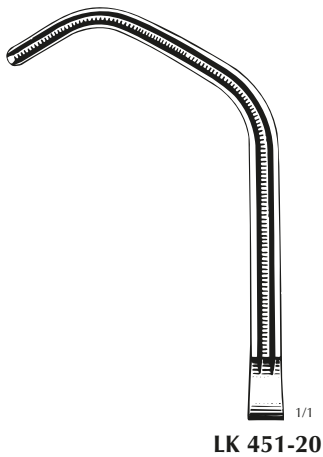

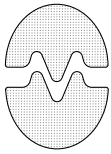

DeBakey-Zahnung  
DeBakey serration  
Bocas tipo DeBakey

**Atraumatische Gefäßklemmen**  
**Atraumatic Vascular Clamps**  
**Pinzas vasculares atraumáticas**



**Weber**

Aortaklemme, links gebogen  
Aortic clamps, curved to left  
Pinzas para aorta, curva de izquierda  
**LK 461-24** 24 cm / 9½"

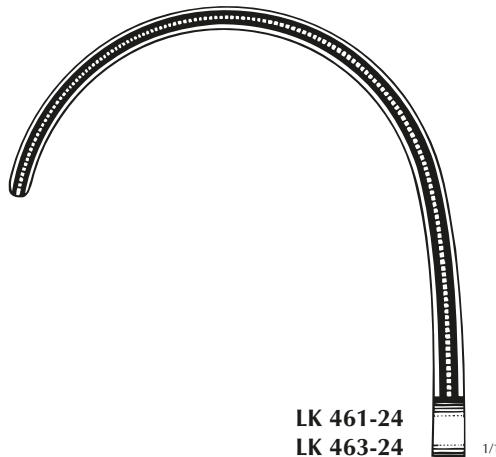

**LK 461-24**  
**LK 463-24**

1/1

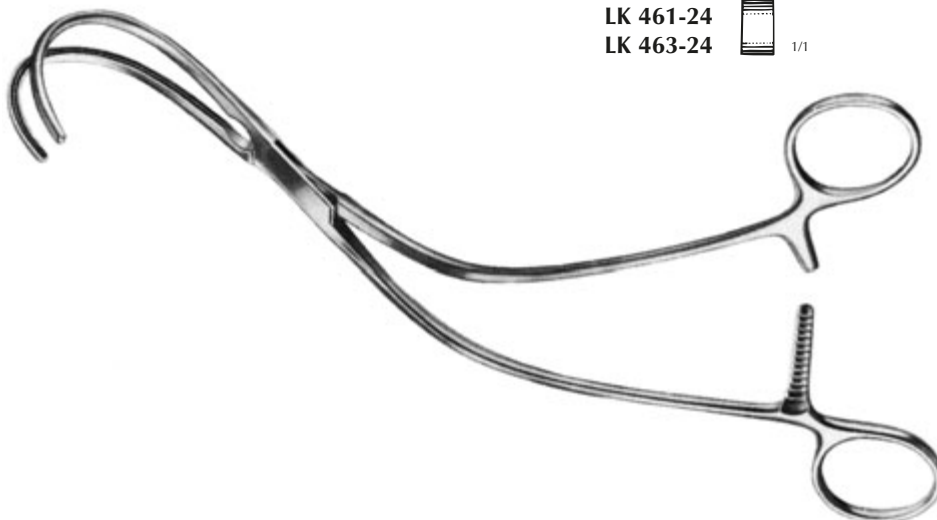

**Weber**

Aortaklemme, rechts gebogen  
Aortic clamps, curved to right  
Pinzas para aorta, curva de derecha  
**LK 463-24** 24 cm / 9½"

**Atraumatische Gefäßklemmen**  
**Atraumatic Vascular Clamps**  
**Pinzas vasculares atraumáticas**

**DeBaKey-Zahnung**  
**DeBaKey serration**  
**Bocas tipo DeBaKey**

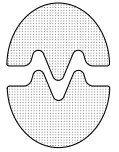

**Lambert-Kay**  
 Aortaklemme  
 Aortic clamp  
 Pinza para aorta  
**LK 471-21** 21 cm / 8 1/4"

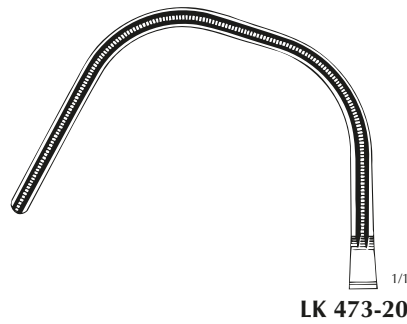

**Kay**  
 Aortaklemme  
 Aortic clamp  
 Pinza para aorta  
**LK 473-20** 20 cm / 8"

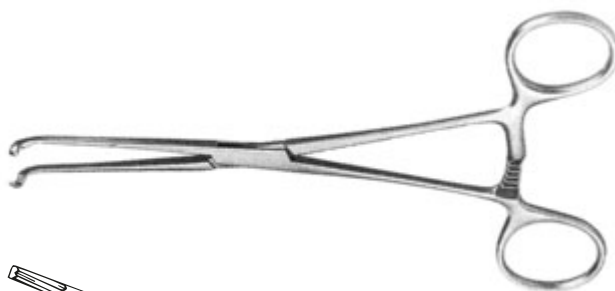

**Javid**  
 Karotisshunt-Klemmen  
 Carotid Shunt Clamps  
 Pinza para shunt de carotis

ø 3,6 mm  
**LK 481-16** 16 cm / 6 1/4"

ø 6 mm  
**LK 481-18** 18,5 cm / 7 1/4"

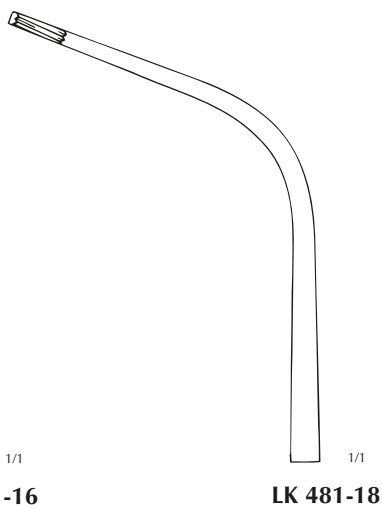
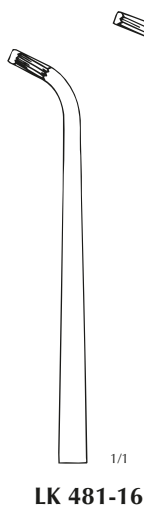



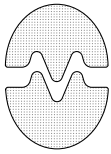

DeBailey-Zahnung  
DeBailey serration  
Bocas tipo DeBailey

**Atraumatische Gefäßklemmen**  
**Atraumatic Vascular Clamps**  
**Pinzas vasculares atraumáticas**



**Dale**

Peripheralklemmen

Peripheral clamps

Pinzas perifericas

**LK 491-17** 17 cm / 6<sup>3</sup>/<sub>4</sub>"

**LK 491-18** 18 cm / 7"

**LK 491-19** 19 cm / 7<sup>1</sup>/<sub>2</sub>"

**LK 493-18** 18 cm / 7"

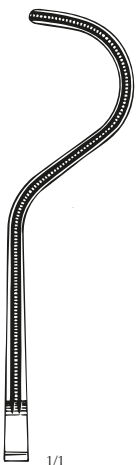

LK 491-17

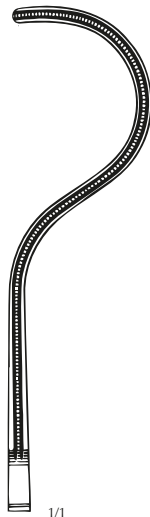

LK 491-18

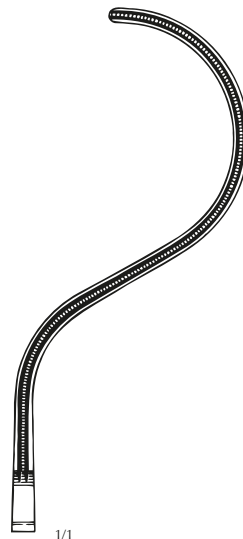

LK 491-19

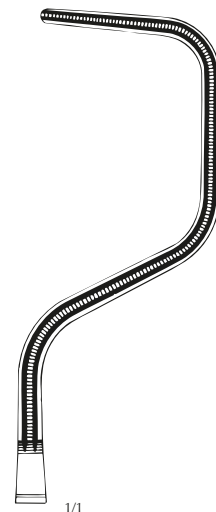

LK 493-18

**Atraumatische Gefäßklemmen**  
**Atraumatic Vascular Clamps**  
**Pinzas vasculares atraumáticas**

**DeBakey-Zahnung**  
**DeBakey serration**  
**Bocas tipo DeBakey**

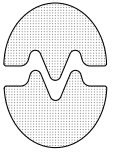

**Glover**  
 Coarctationsklemmen  
 Coarctation clamps  
 Pinzas para coarctación  
 gerade - straight - recta  
**LK 500-21** 21 cm / 8¼"  
**LK 500-22** 22 cm / 8¾"

Maul aufgewinkelt  
 Jaws angled on flat  
 Bocas anguladas de plano  
**LK 501-21** 21 cm / 8¼"  
**LK 501-22** 22 cm / 8¾"



Branchen aufgewinkelt  
 Handles angled on flat  
 Mangos angulados de plano  
**LK 503-21** 21 cm / 8¼"  
**LK 503-22** 22 cm / 8¾"

löffelförmig - spoon-shaped - forma de cuchara  
**LK 507-21** 21 cm / 8¼"

gebogen - curved - curva  
**LK 509-22** 22 cm / 8¾"

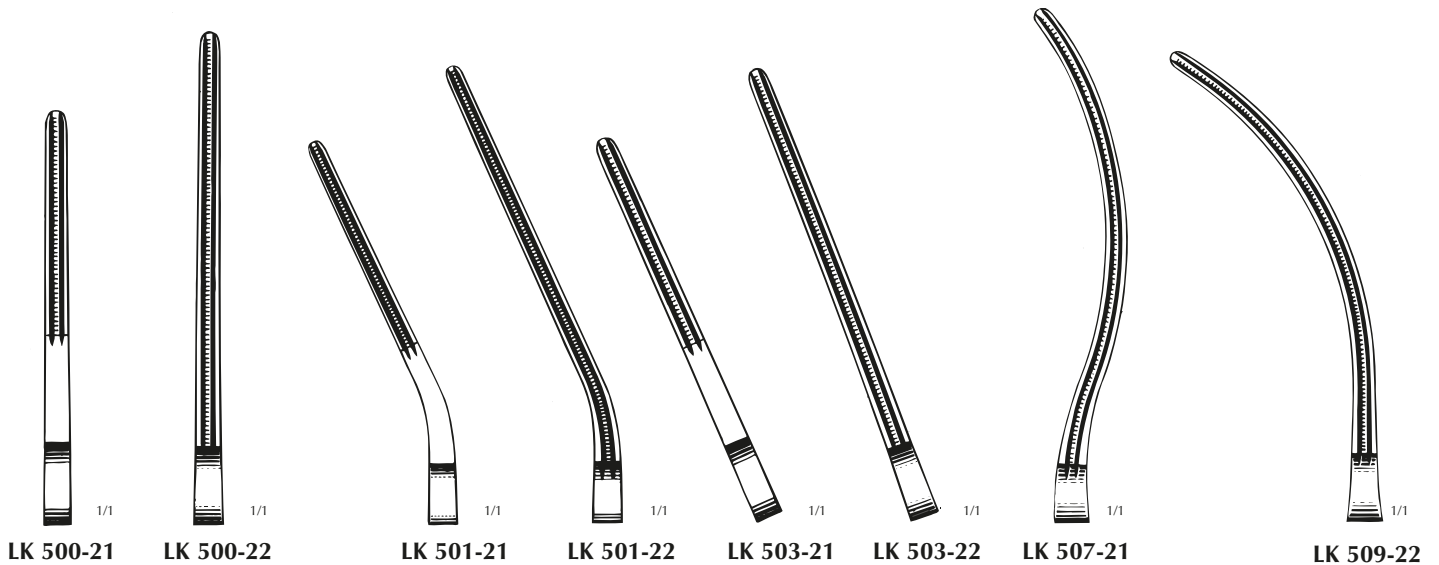

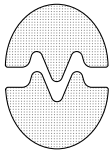

DeBailey-Zahnung  
DeBailey serration  
Bocas tipo DeBailey

**Atraumatische Gefäßklemmen**  
**Atraumatic Vascular Clamps**  
**Pinzas vasculares atraumáticas**



**Dietrich**

Aortaklemme  
Aortic clamp  
Pinza para aorta

**LK 511-22** 22 cm / 8<sup>3</sup>/<sub>4</sub>"

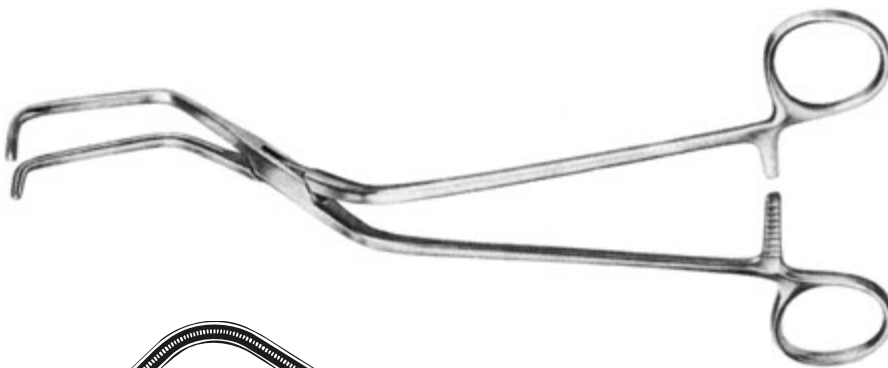
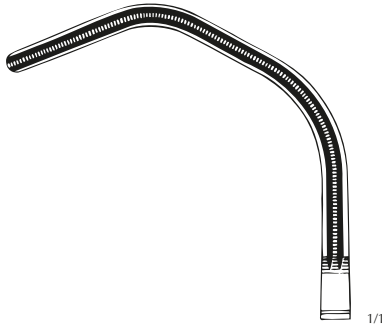

**Ochsner**

Aortaklemme  
Aortic clamp  
Pinza de aorta

**LK 513-23** 23,5 cm / 9<sup>1</sup>/<sub>4</sub>"



**Atraumatische Gefäßklemmen**  
**Atraumatic Vascular Clamps**  
**Pinzas vasculares atraumáticas**

DeBakey-Zahnung  
DeBakey serration  
Bocas tipo DeBakey

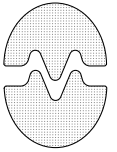

**DeBakey-Beck**  
Tangentialklemmen  
Tangential occlusion clamps  
Pinzas para oclusión tangencial

<b>LK 517-16</b>	16,5 cm / 6½"
<b>LK 517-19</b>	19,5 cm / 7¾"
<b>LK 517-20</b>	20,5 cm / 8"

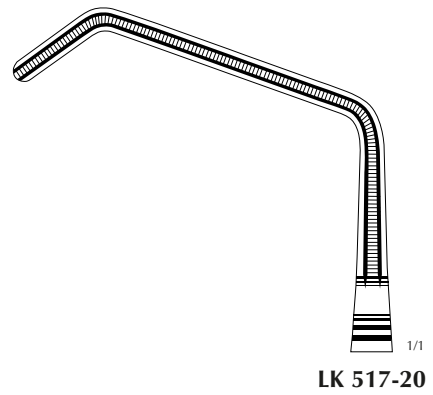
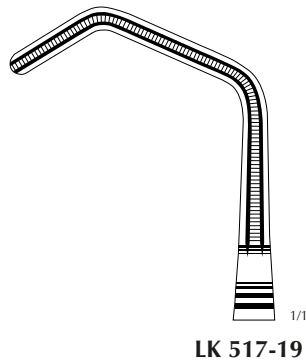
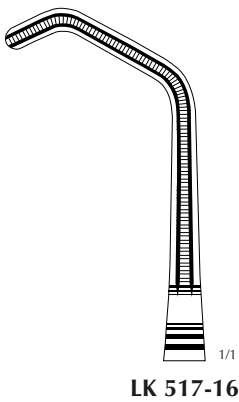

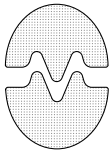

DeBakey-Zahnung  
DeBakey serration  
Bocas tipo DeBakey

**Atraumatische Gefäßklemmen**  
**Atraumatic Vascular Clamps**  
**Pinzas vasculares atraumáticas**

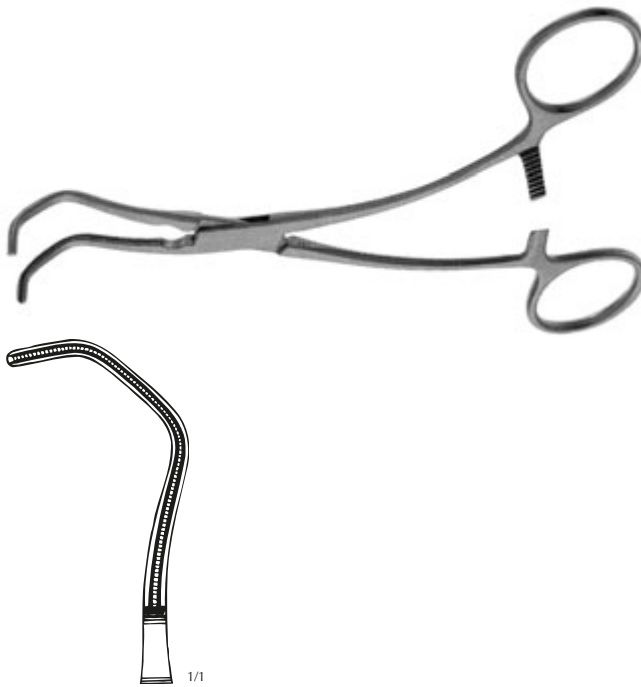

**DeBakey**  
Anastomosenklemme  
Anastomosis clamp  
Pinza para anastomosis  
**LK 521-17** 17 cm / 6¾"



**DeBakey-Derra**  
Anastomosenklemmen  
Anastomosis clamps  
Pinzas para anastomosis  
**LK 523-16** 16 cm / 6¼"  
**LK 523-17** 17 cm / 6¾"  
**LK 523-18** 18 cm / 7"

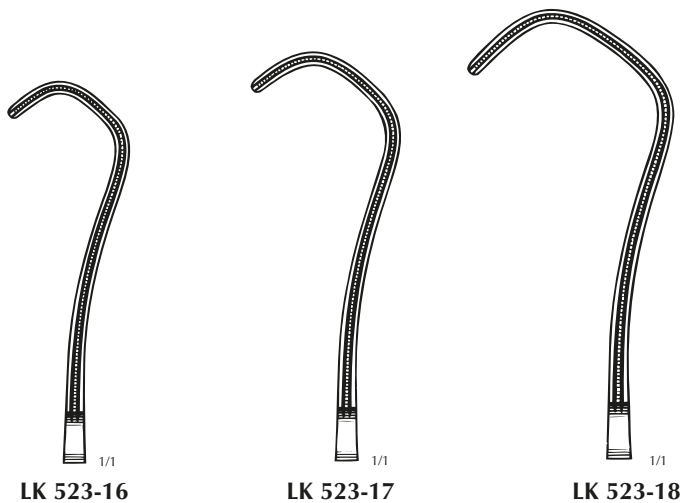

**LK 523-16**

**LK 523-17**

**LK 523-18**

**Atraumatische Gefäßklemmen**  
**Atraumatic Vascular Clamps**  
**Pinzas vasculares atraumáticas**

DeBaKey-Zahnung  
 DeBaKey serration  
 Bocas tipo DeBaKey

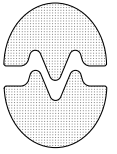

**Lees**

Bronchusklemmen

Bronchus clamps

Pinzas bronquiales

**LK 525-23** 23 cm / 9"

**LK 525-25** 25 cm / 10"

**LK 531-25** 25 cm / 10"

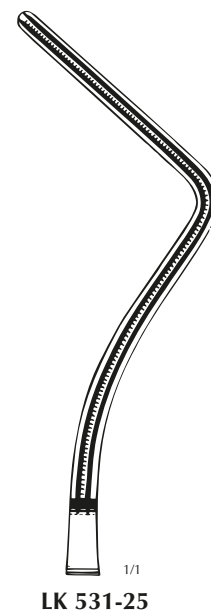
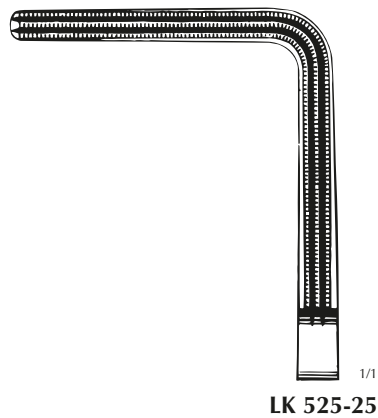

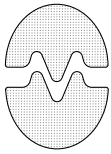

DeBakey-Zahnung  
DeBakey serration  
Bocas tipo DeBakey

## Atraumatische Gefäßklemmen Atraumatic Vascular Clamps Pinzas vasculares atraumáticas



### Gregory

Profundaklemmen  
Profunda clamps  
Pinzas para profunda

**LK 541-14** 14 cm / 5½"  
**LK 541-16** 16 cm / 6¼"  
**LK 541-18** 18 cm / 7"

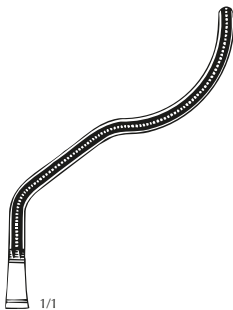

LK 541-14

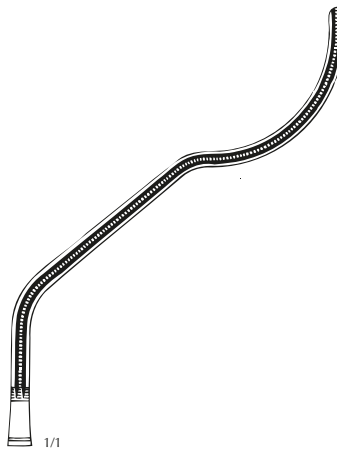

LK 541-16

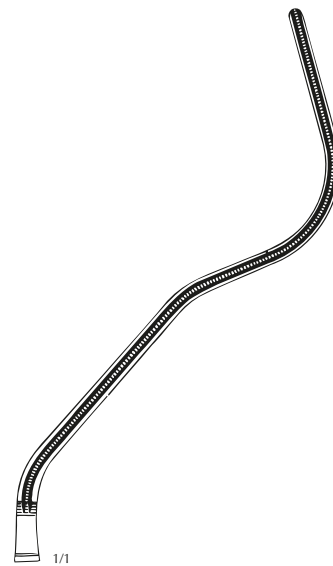

LK 541-18

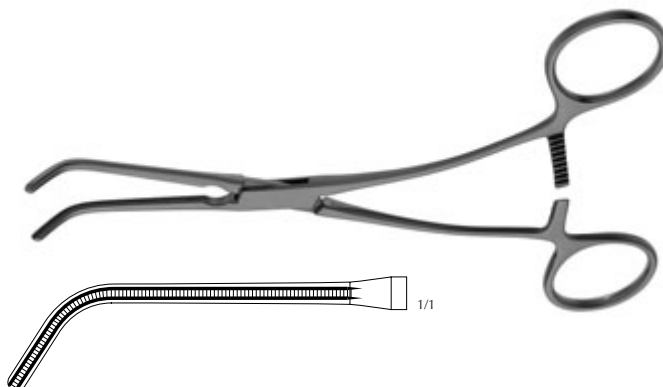

### Eriksson

Karotisklemme, aufgewinkelt  
Carotid clamp, angled on flat  
Pinza de carotis, angulada de plano

**LK 551-17** 17 cm / 6¾"

**Atraumatische Gefäßklemmen**  
**Atraumatic Vascular Clamps**  
**Pinzas vasculares atraumáticas**

DeBaKey-Zahnung  
 DeBaKey serration  
 Bocas tipo DeBaKey

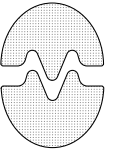

**Bainbridge**

gerade - straight - recta

**LK 560-15** 15 cm / 6"

**LK 560-18** 18 cm / 7"

gebogen - curved - curva

**LK 561-15** 15 cm / 6"

**LK 561-18** 18 cm / 7"

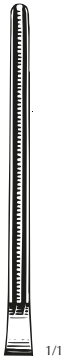

**LK 560-15** 1/1

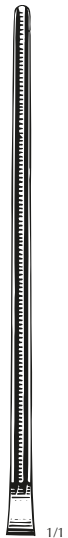

**LK 560-18** 1/1

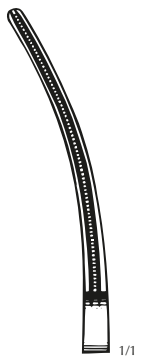

**LK 561-15** 1/1

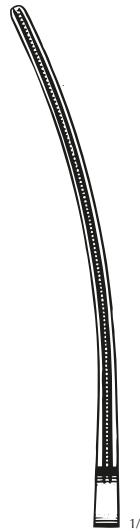

**LK 561-18** 1/1



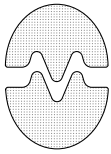

DeBailey-Zahnung  
DeBailey serration  
Bocas tipo DeBailey

## Atraumatische Gefäßklemmen Atraumatic Vascular Clamps Pinzas vasculares atraumáticas



### Leland-Jones

Peripheralklemmen

Peripheral clamps

Pinzas perifericas

**LK 571-18** 18 cm / 7"

**LK 571-19** 19 cm / 7½"

**LK 571-20** 20 cm / 8"

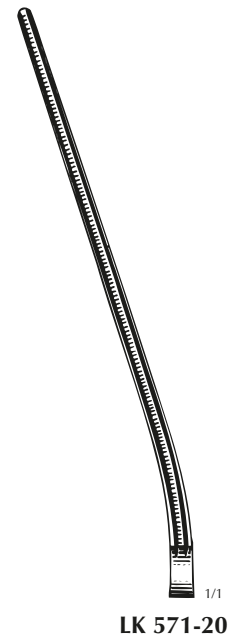
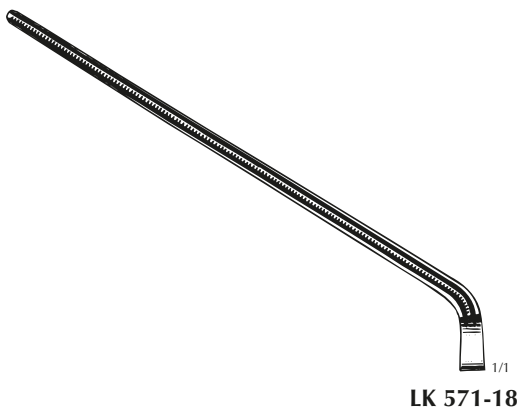

**Atraumatische Gefäßklemmen**  
**Atraumatic Vascular Clamps**  
**Pinzas vasculares atraumáticas**

Cooley-Zahnung  
 Cooley serration  
 Bocas tipo Cooley

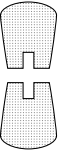

**Cooley**  
 Mehrzweckklemmen, aufgewinkelt  
 Multi-purpose clamps, angled on flat  
 Pinzas multi-funcionales, anguladas de plano

- 30°  
**LK 581-15**    15 cm / 6"
- 60°  
**LK 583-15**    15 cm / 6"
- 90°  
**LK 585-13**    13 cm / 5"

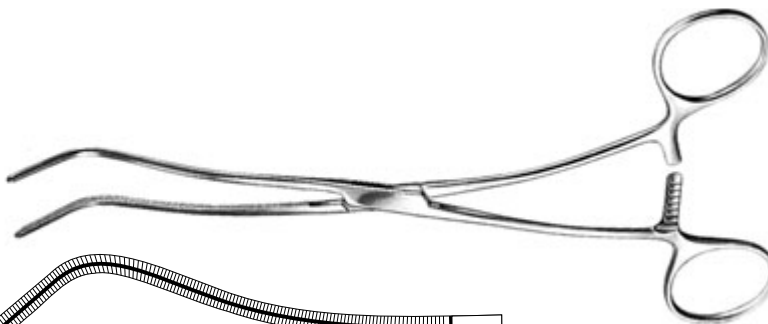
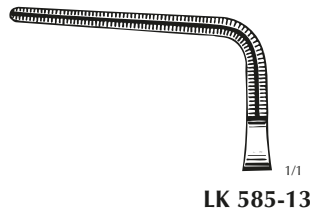
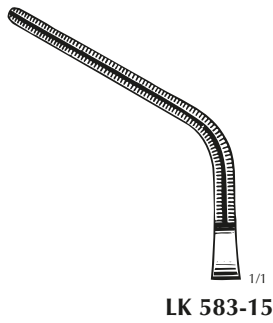
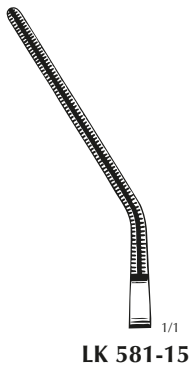

**Cooley**  
 Nierenarterienklemmen  
 Renal artery clamps  
 Pinzas para arteria renal

- LK 589-18**    18,5 cm / 7¼"
- LK 589-22**    22 cm / 8¾"
- LK 589-27**    27 cm / 10¾"

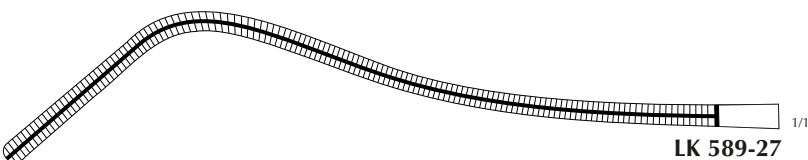
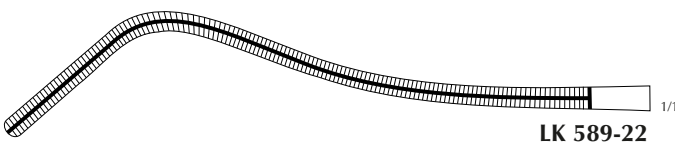
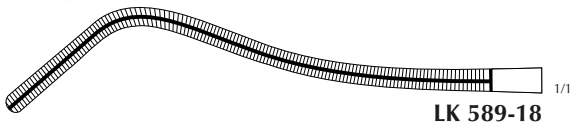

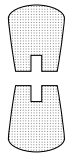

Cooley-Zahnung  
Cooley serration  
Bocas tipo Cooley

## Atraumatische Gefäßklemmen Atraumatic Vascular Clamps Pinzas vasculares atraumáticas



**Cooley**  
Iliacaklemme  
Iliac clamp  
Pinza de iliaca  
**LK 593-22** 22 cm / 8<sup>3</sup>/<sub>4</sub>"



**Cooley**  
Anastomosenklemme  
Anastomosis clamp  
Pinza para anastomosis  
**LK 603-17** 17 cm / 6<sup>3</sup>/<sub>4</sub>"

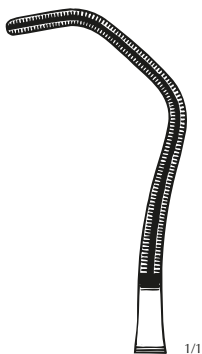

**Atraumatische Gefäßklemmen**  
**Atraumatic Vascular Clamps**  
**Pinzas vasculares atraumáticas**

Cooley-Zahnung  
 Cooley serration  
 Bocas tipo Cooley

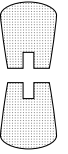

**Cooley-Derra**

Anastomosenklemmen, graduert  
 Anastomosis clamps, graduated  
 Pinzas para anastomosis, graduato

- LK 621-16** 16 cm / 6¼"
- LK 621-17** 17 cm / 6¾"
- LK 621-18** 18 cm / 7"

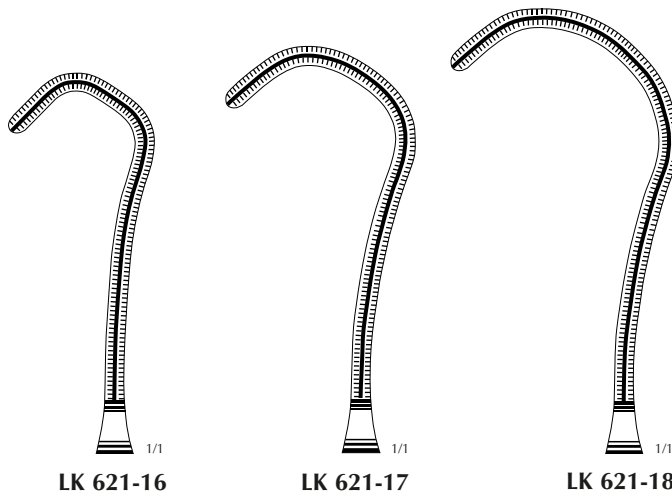

LK 621-16

LK 621-17

LK 621-18



**Cooley-Beck**

graduirt - graduated - graduato

- LK 631-15** 15 cm / 6"
- LK 633-15** 15 cm / 6"

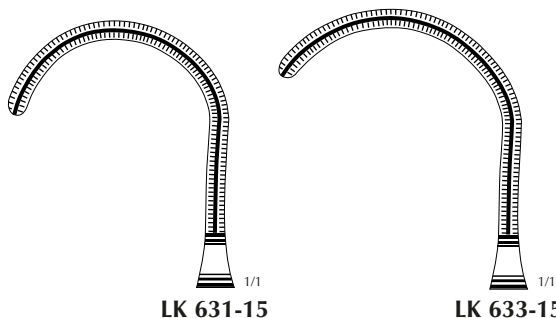

LK 631-15

LK 633-15

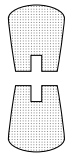

Cooley-Zahnung  
Cooley serration  
Bocas tipo Cooley

**Atraumatische Gefäßklemmen**  
**Atraumatic Vascular Clamps**  
**Pinzas vasculares atraumáticas**



**Cooley**

Mehrweckklemmen 60°

Multi-purpose clamps 60°

Pinzas multi-funcionales 60°

**LK 651-21** 21 cm / 8¼"

**LK 651-23** 23 cm / 9"

**LK 651-26** 26 cm / 10¼"

**LK 651-30** 30,5 cm / 12"

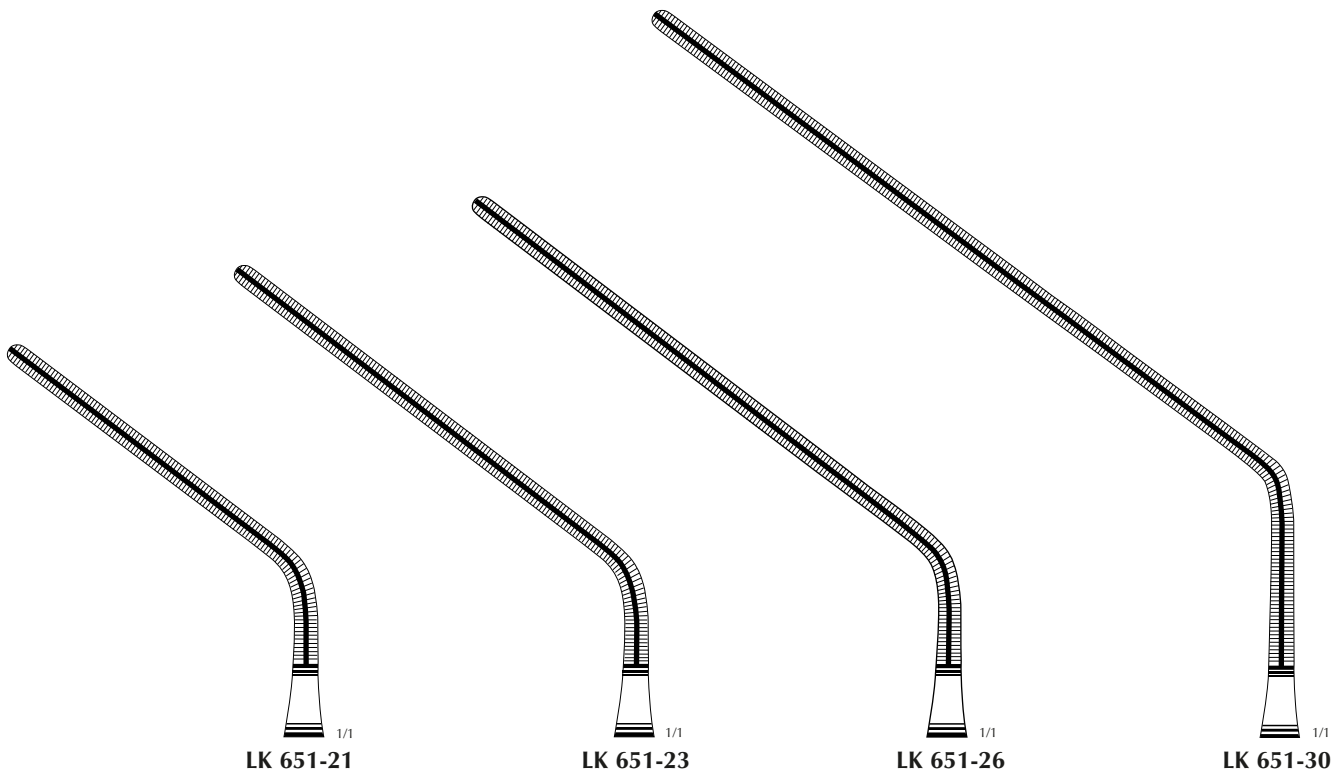

LK 651-21 1/1

LK 651-23 1/1

LK 651-26 1/1

LK 651-30 1/1

**Atraumatische Gefäßklemmen**  
**Atraumatic Vascular Clamps**  
**Pinzas vasculares atraumáticas**

**Cooley-Zahnung**  
**Cooley serration**  
**Bocas tipo Cooley**

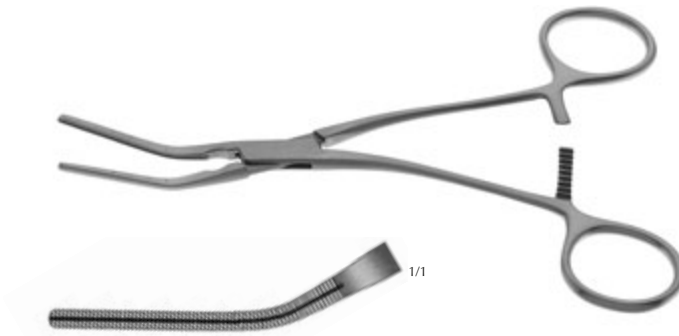
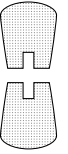

**Cooley**  
Mehrzweckklemmen 30°, graduiert  
Multi-purpose clamps 30°, graduated  
Pinzas multi-funcionales 30°, graduato  
**LK 661-16** 16 cm / 6¼"

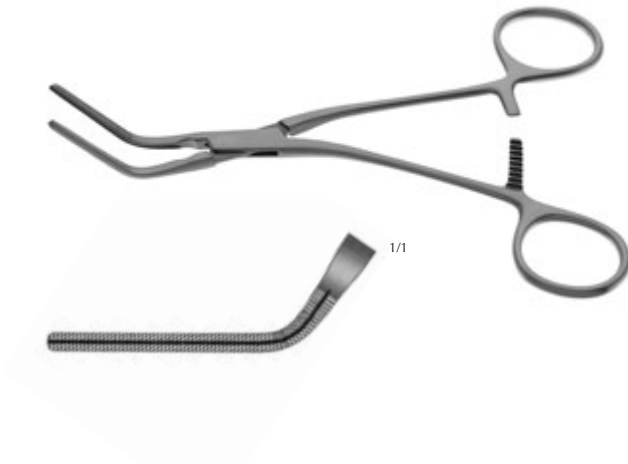

**Cooley**  
Mehrzweckklemmen 60°, graduiert  
Multi-purpose clamps 60°, graduated  
Pinzas multi-funcionales 60°, graduato  
**LK 663-15** 15 cm / 6"

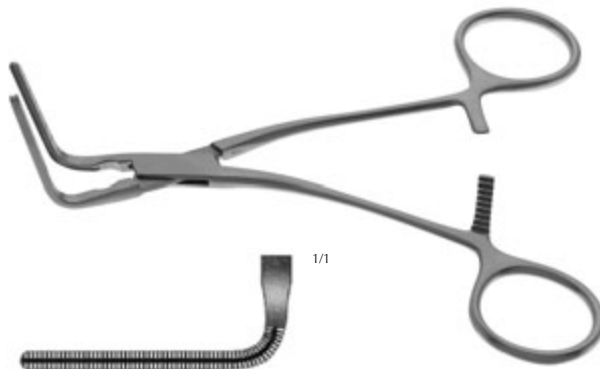

**Cooley**  
Mehrzweckklemmen 90°, graduiert  
Multi-purpose clamps 90°, graduated  
Pinzas multi-funcionales 90°, graduato  
**LK 665-15** 15 cm / 6"

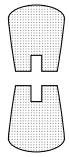

Cooley-Zahnung  
Cooley serration  
Bocas tipo Cooley

## Atraumatische Gefäßklemmen Atraumatic Vascular Clamps Pinzas vasculares atraumáticas



### Cooley

Mehrweckklemmen, graduiert  
Multi-purpose clamps, graduated  
Pinzas multi-funcionales, graduato

**LK 671-18** 18,5 cm / 7¼"

**LK 671-19** 19,5 cm / 7¾"

**LK 671-27** 27 cm / 10¾"

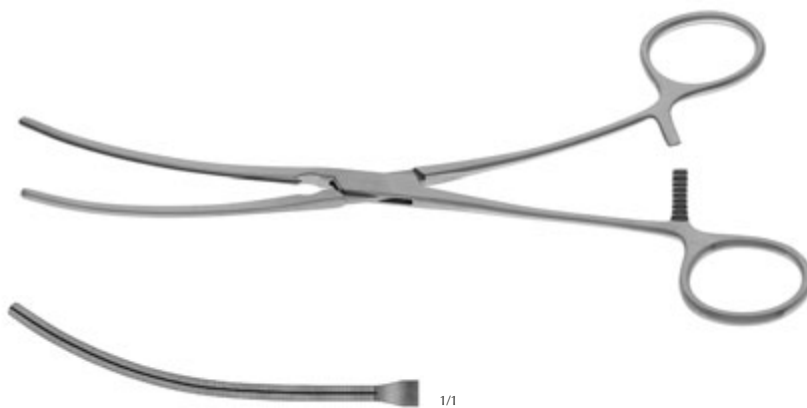

### Cooley

Mehrweckklemme, graduiert  
Multi-purpose clamps, graduated  
Pinza multi-funcionales, graduato

**LK 675-19** 19 cm / 7½"

**Atraumatische Gefäßklemmen**  
**Atraumatic Vascular Clamps**  
**Pinzas vasculares atraumáticas**

Cooley-Zahnung  
 Cooley serration  
 Bocas tipo Cooley

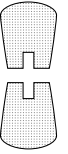

**Cooley**  
 Aortaklemmen  
 Aortic clamps  
 Pinzas para aorta

- LK 681-22** 22 cm / 8<sup>3</sup>/<sub>4</sub>"
- LK 681-26** 26 cm / 10<sup>1</sup>/<sub>4</sub>"
- LK 681-27** 27 cm / 10<sup>3</sup>/<sub>4</sub>"

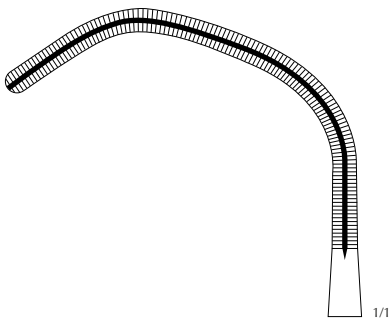

**LK 681-22**

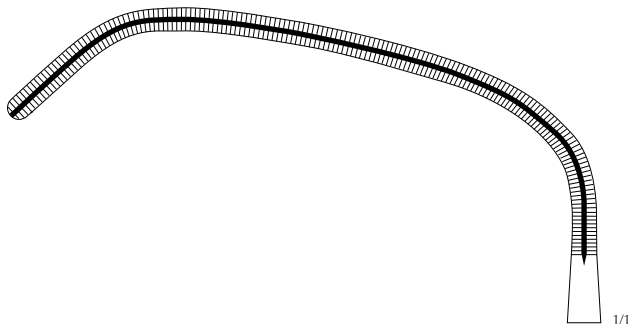

**LK 681-26**

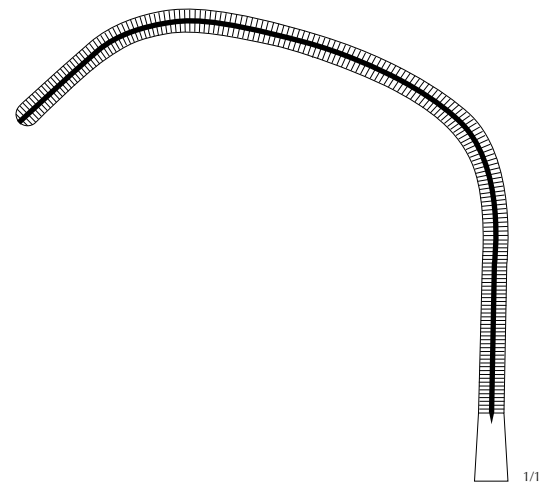

**LK 681-27**



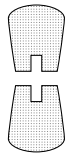

Cooley-Zahnung  
Cooley serration  
Bocas tipo Cooley

## Atraumatische Gefäßklemmen Atraumatic Vascular Clamps Pinzas vasculares atraumáticas

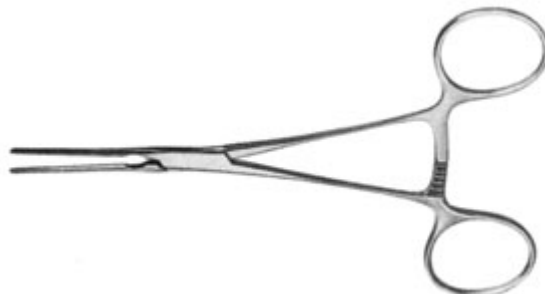

**Cooley**  
Kinderklemmen  
Pediatric clamps  
Pinzas pediátricas

gerade - straight - recta  
**LK 900-14** 14 cm / 5½"

aufgewinkelt - angled on flat - angulada de plano  
**LK 901-14** 14 cm / 5½"



**LK 900-14**

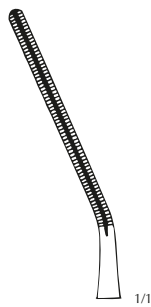

**LK 901-14**

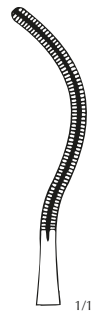

**LK 903-14**

löffelförmig - spoon-shaped - forma de cuchara  
**LK 903-14** 14 cm / 5½"

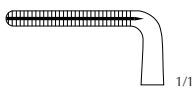

**LK 905-01**

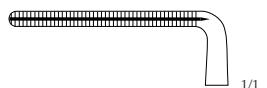

**LK 905-02**

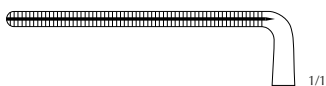

**LK 905-03**

aufgewinkelt 90°  
angled 90°  
angulada 90°  
**LK 905-01** 12 cm / 4¾"  
**LK 905-02** 12 cm / 4¾"  
**LK 905-03** 12 cm / 4¾"

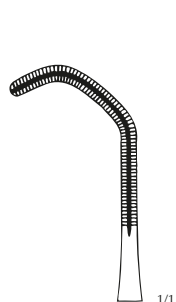

**LK 907-14**

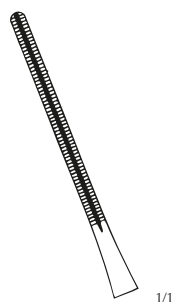

**LK 909-14**

aufgewinkelt - angled on flat - angulada de plano  
**LK 907-14** 14 cm / 5½"

Branchen aufgewinkelt  
Handles angled on flat  
Mangos angulados de plano  
**LK 909-14** 14 cm / 5½"

**Atraumatische Gefäßklemmen**  
**Atraumatic Vascular Clamps**  
**Pinzas vasculares atraumáticas**

Cooley-Zahnung  
Cooley serration  
Bocas tipo Cooley

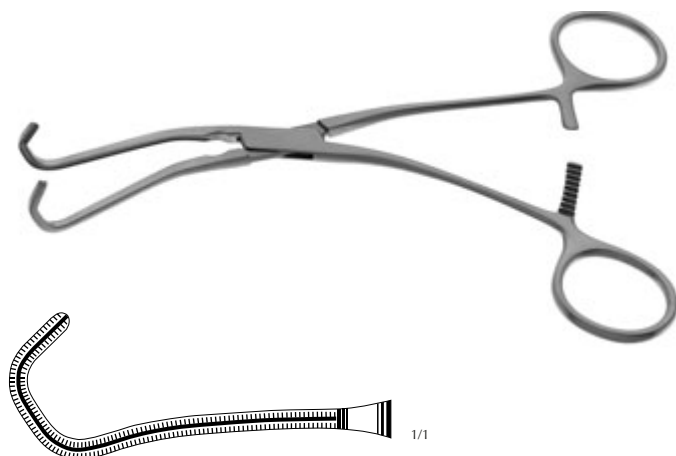
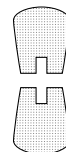

Cooley  
LK 911-17 17 cm / 6¾"

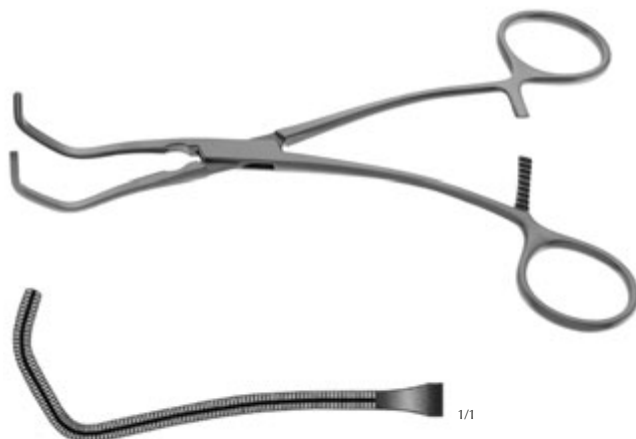

Cooley  
LK 913-16 16 cm / 6¼"

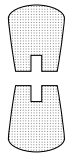

Cooley-Zahnung  
Cooley serration  
Bocas tipo Cooley

**Atraumatische Gefäßklemmen**  
**Atraumatic Vascular Clamps**  
**Pinzas vasculares atraumáticas**

**Baby-Cooley**

Neonataalklemmen

Neonatal vascular clamps

Pinzas neonatales

**LK 914-12** 12,5 cm / 5"

**LK 915-12** 12 cm / 4¾"

**LK 917-12** 12 cm / 4¾"

**LK 921-11** 11,5 cm / 4½"

**LK 923-12** 12 cm / 4¾"

**LK 925-12** 12,5 cm / 5"

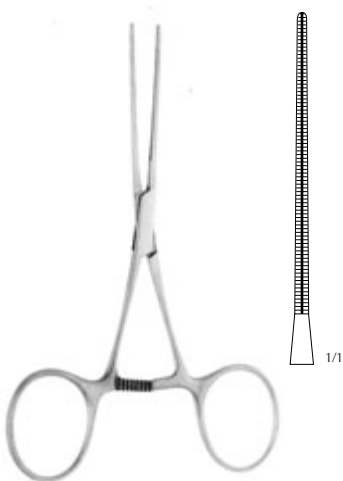

**LK 914-12**

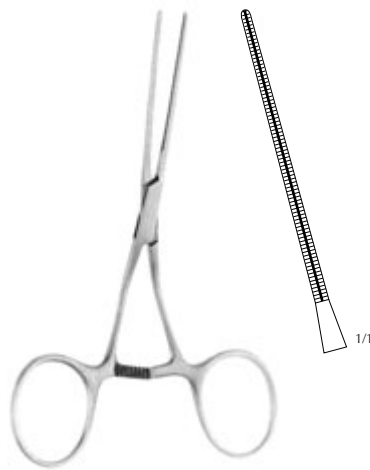

**LK 915-12**



**LK 917-12**

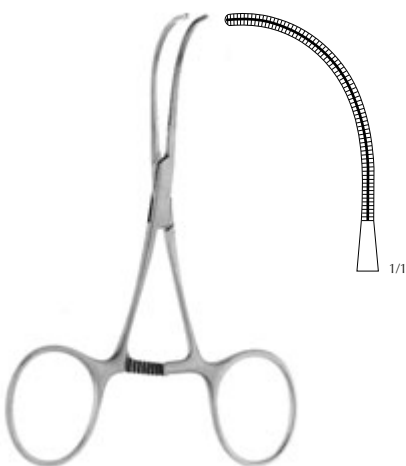

**LK 921-11**

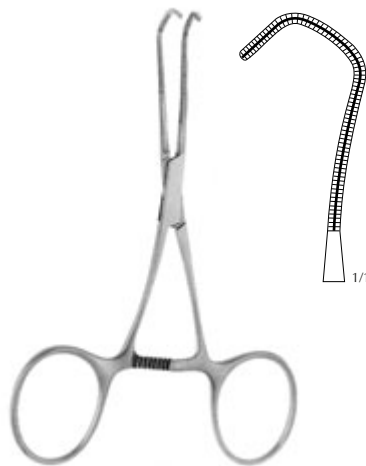

**LK 923-12**

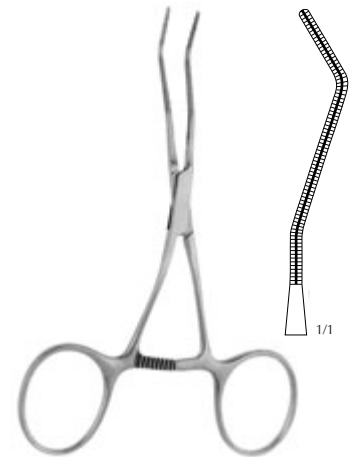

**LK 925-12**

**Atraumatische Gefäßklemmen**  
**Atraumatic Vascular Clamps**  
**Pinzas vasculares atraumáticas**

**Cooley-Zahnung**  
**Cooley serration**  
**Bocas tipo Cooley**

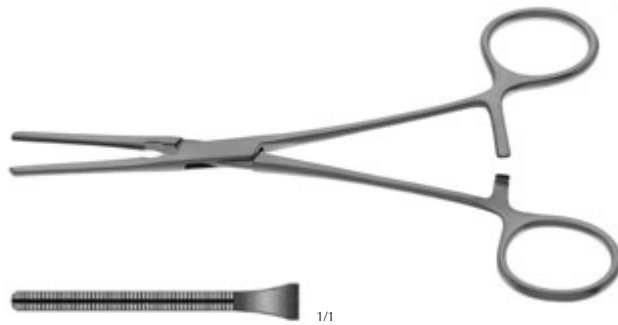
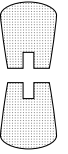

**Cooley**  
 Patent – Ductusklemmen, gerade  
 Patent – Ductus- Clamps, straight  
 Patent – Pinza ductus, recta

**LK 940-16** 16 cm / 6¼"  
**LK 940-17** 17 cm / 6¾"

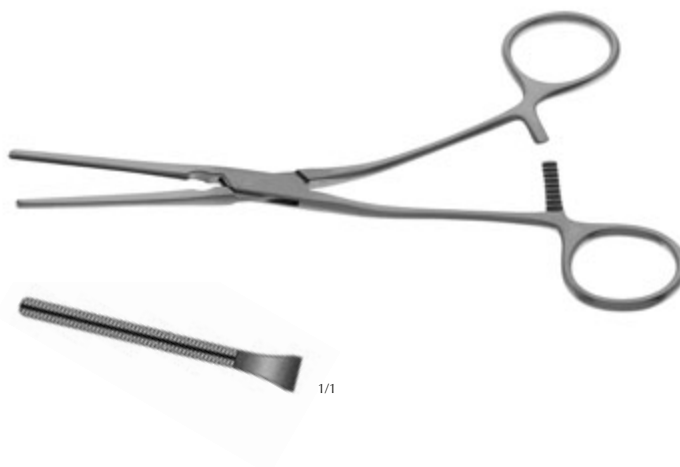

**Cooley**  
 Patent – Ductusklemmen  
 Patent – Ductus-clamps  
 Patent – Pinza patente de conducto

15° aufgewinkelt - 15° angled - 15° angulada

**LK 941-16** 16 cm / 6¼"  
**LK 941-17** 17 cm / 6¾"

**Atraumatische Gefäßklemmen**  
**Atraumatic Vascular Clamps**  
**Pinzas vasculares atraumáticas**



**Castañeda**

Feine Neonatalklemmen  
Fine neonatal vascular clamps  
Pinzas finas neonatales

aufgewinkelt - angled on flat - angulada de plano

**LK 951-01** 13 cm / 5"

**LK 951-02** 13 cm / 5"

**LK 951-03** 11 cm / 4¼"

aufgebogen - curved on flat - curva de plano

**LK 955-01** 12 cm / 4¾"

**LK 955-02** 12 cm / 4¾"

**LK 955-03** 12 cm / 4¾"

**LK 955-04** 12 cm / 4¾"

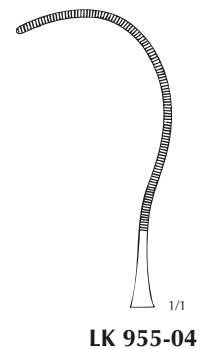
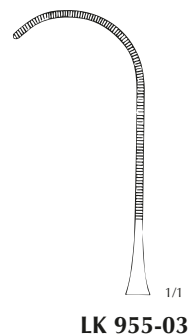
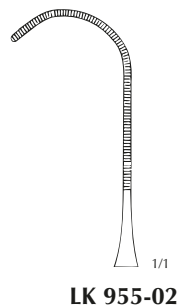
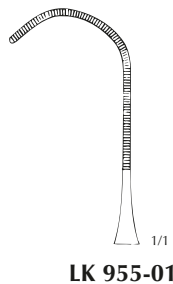
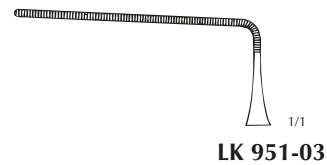
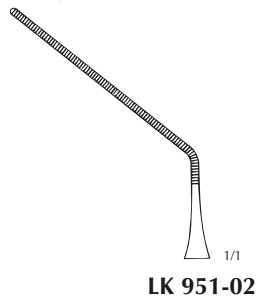
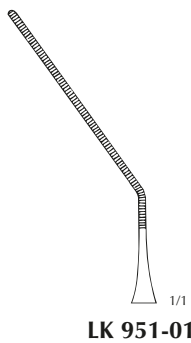

**Atraumatische Gefäßklemmen**  
**Atraumatic Vascular Clamps**  
**Pinzas vasculares atraumáticas**

**Dardik-Zahnung**  
**Dardik serration**  
**Bocas tipo Dardik**

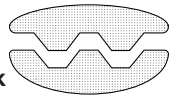

**Dardik**

Mehrweckklemmen,  
Maulbreite 4 mm

Multi-purpose clamps,  
jaw width 4 mm

Pinzas multi-funcionales,  
anchura de boca 4 mm

gerade - straight - recta

**LK 970-15** 15 cm / 6"

**LK 970-17** 17 cm / 6¾"

aufgewinkelt

angled on flat

angulada de plano

15°

**LK 971-15** 15 cm / 6"

**LK 971-17** 17 cm / 6¾"

30°

**LK 973-15** 15 cm / 6"

**LK 973-17** 17 cm / 6¾"

45°

**LK 975-15** 15 cm / 6"

**LK 975-17** 17 cm / 6¾"

90°

**LK 977-14** 14 cm / 5½"

**LK 977-16** 16 cm / 6¼"



**Gefäßklemmen**  
**Vascular Clamps**  
**Pinzas vasculares**

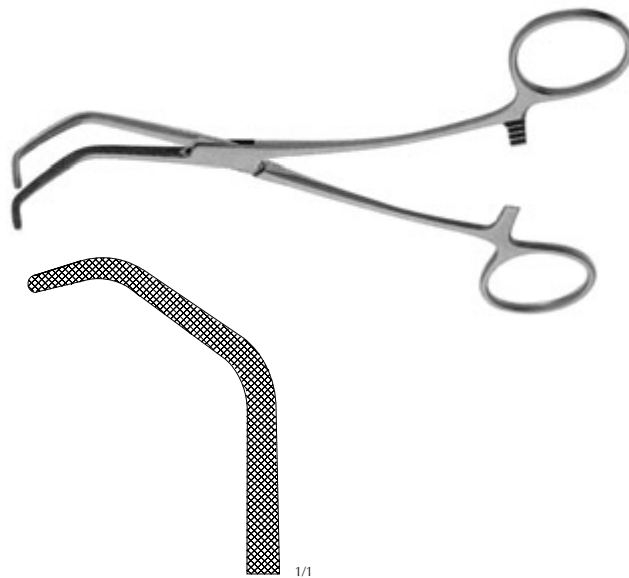

**Satinsky**  
Vena Cava-Klemme, kariert  
Vena cava clamp, cross serrated  
Pinza para vena cava, estrias cruzadas  
**LM 101-16** 16 cm / 6¼"

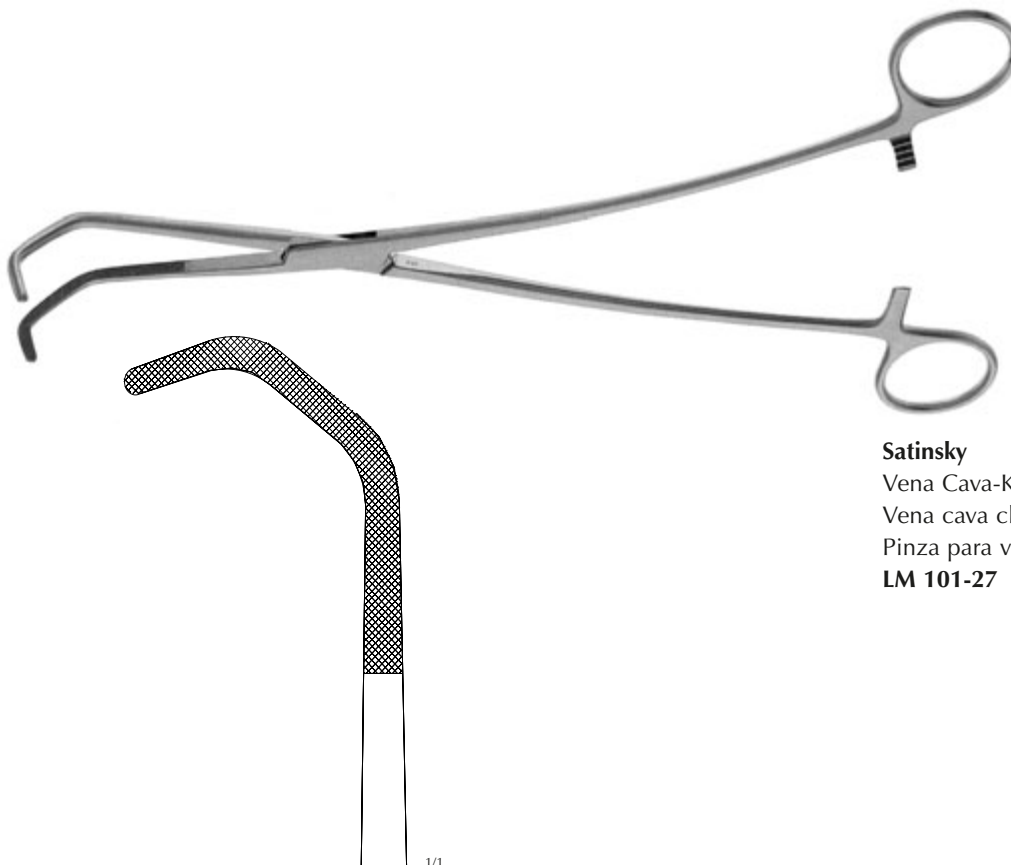

**Satinsky**  
Vena Cava-Klemme, kariert  
Vena cava clamp, cross serrated  
Pinza para vena cava, estrias cruzadas  
**LM 101-27** 27,5 cm / 10¾"

## Bronchusklemmen

### Bronchus Forceps

### Pinzas-clamps bronquiales

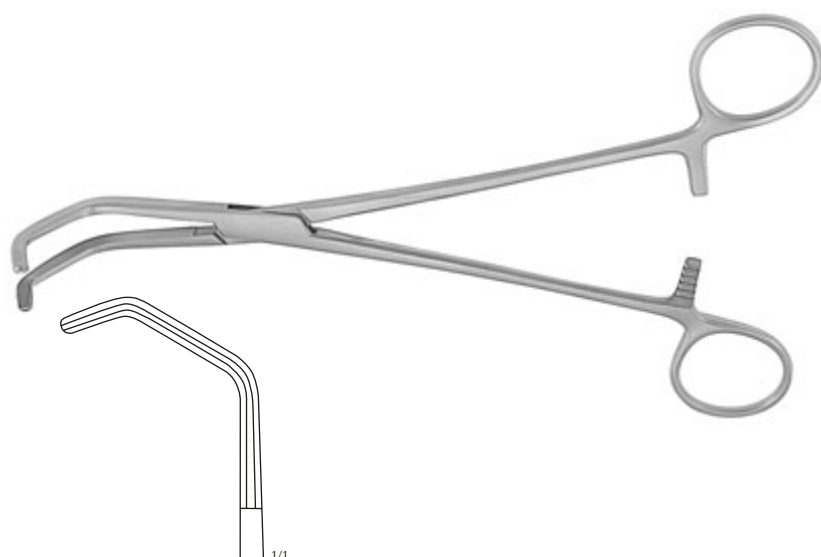

**Price-Thomas**

**LM 207-22** 22 cm / 8¾"



**Price-Thomas**

mit Stiften im Maul – jaw with pins  
boca con dientes

**LM 209-22** 22 cm / 8¾"

**LM 211-22** 22 cm / 8¾"



**LM 209-22**



**LM 211-22**



**Sarot**

mit Stiften im Maul – jaw with pins  
boca con dientes

**LM 215-23** 23 cm / 9"

**LM 217-23** 23 cm / 9"



**LM 215-23**



**LM 217-23**



**Aurikelklemmen**  
**Auricle Clamps**  
**Pinzas para auricula**



**Crafoord-Sellors**

gebogen - curved - curva

LM 221-24 24 cm / 9½"

LM 223-23 23 cm / 9"

LM 225-22 22 cm / 8¾"

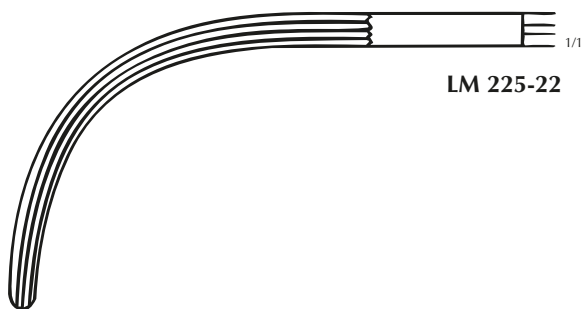
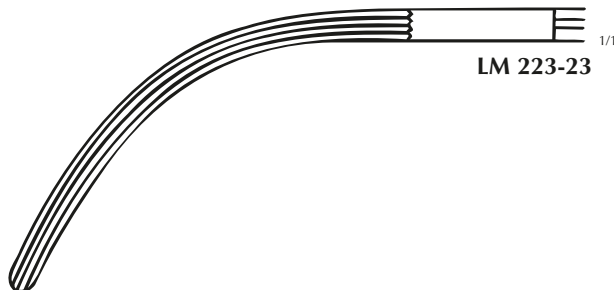

**Präparier- und Ligaturklemmen**  
**Dissecting and Ligature Forceps**  
**Pinzas de disección y ligaduras**



LM 251-24

¼

Semb

LM 251-24

24 cm / 9½"

LM 253-24

24 cm / 9½"

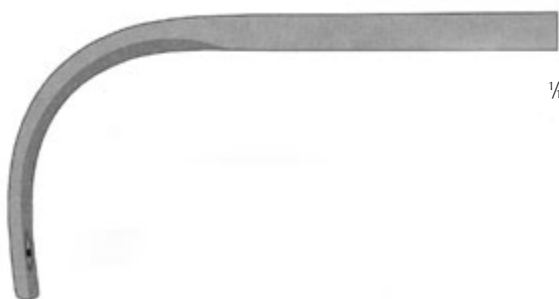

LM 253-24

¼

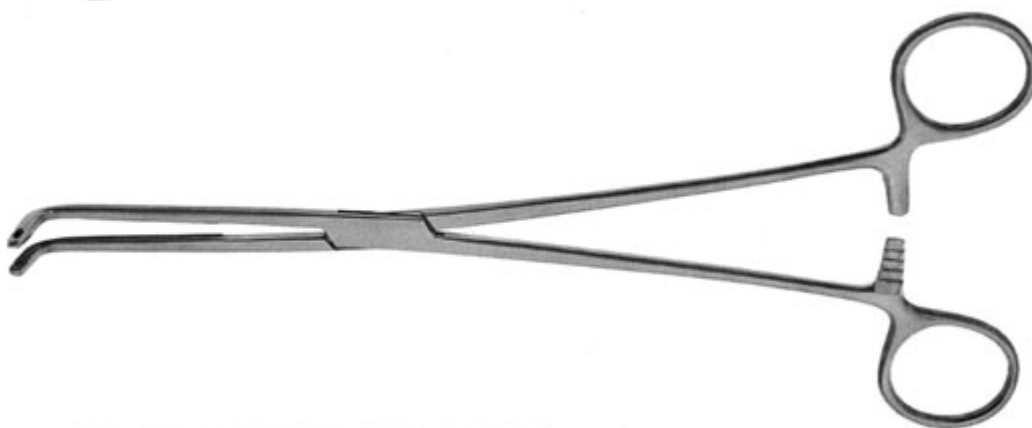

¼

Finochietto

LM 260-24

24 cm / 9½"

**Herzklappenscheren**  
**Heart Valve Scissors**  
**Tijeras de válvula de corazón**

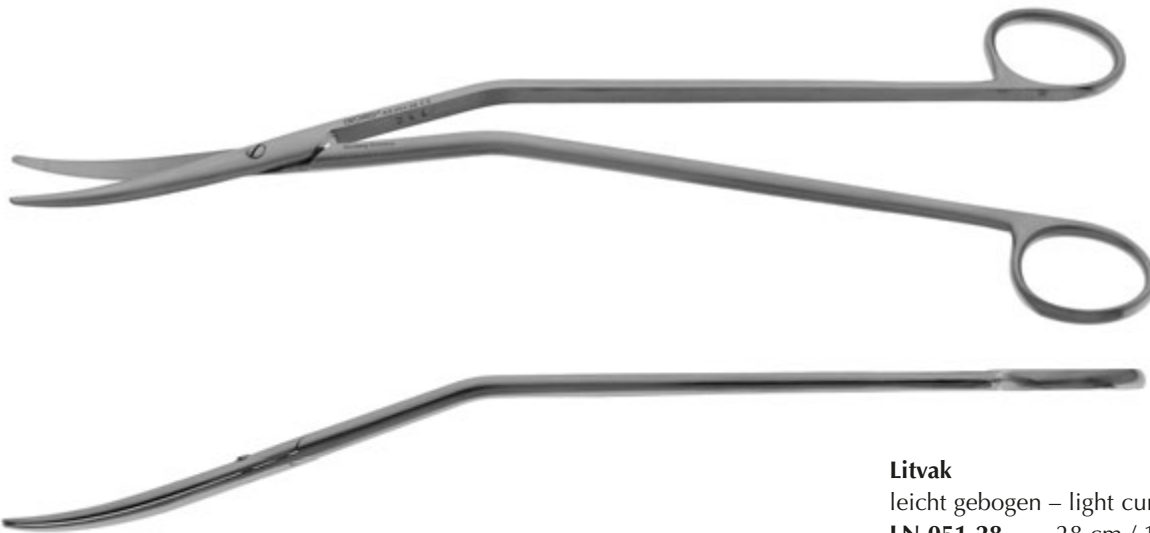

**Litvak**

leicht gebogen – light curved – curva ligera  
**LN 051-28** 28 cm / 11"

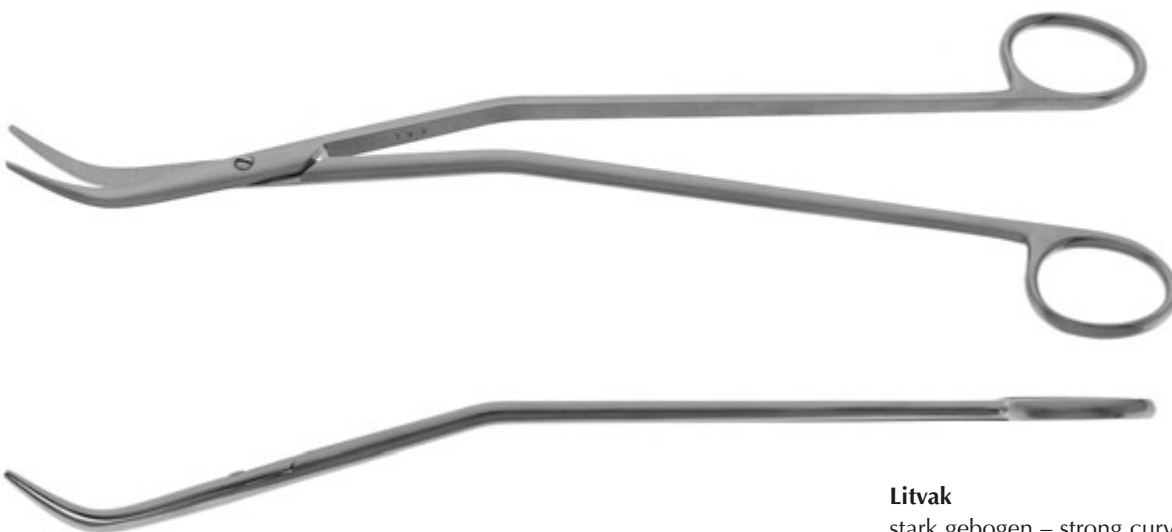

**Litvak**

stark gebogen – strong curved – curva fuerte  
**LN 053-28** 28 cm / 11"

Artikel-Nr.	Menge quantity cantidad	Beschreibung Description descripción
<b>ZT 101-00</b>		
<b>Thorakotomie-Set</b>		
<b>Thoracotomy Set</b>		
<b>Set de Toracotomía</b>		
AA 102-14	1	SURGICAL SCISSOR SH/BL STR 14.5CM
AD 530-17	1	GOLD-CUT MAYO-STILLE SCISSOR STR 17CM
AD 531-17	1	GOLD-CUT MAYO-STILLE SCISSOR CVD 17CM
AD 551-18	1	GOLD-CUT METZENB SCISSOR BL/BL CVD 18CM
AD 551-20	1	GOLD-CUT METZENB SCISSOR BL/BL CVD 20CM
AD 551-28	1	GOLD-CUT METZENB SCISSOR BL/BL CVD 28CM
AD 810-12	1	GOLD-CUT UNIVER WIRE CUT SCS SERR 12,5CM
AE 100-14	2	DRESSING FORCEPS STANDARD STR 14.5CM
AE 100-20	1	DRESSING FORCEPS STANDARD STR 20CM
AE 406-14	2	TISSUE FORCEPS 1X2T STR 14.5CM
AE 406-20	1	TISSUE FORCEPS 1X2T STR 20CM
AE 806-20	2	RUSSIAN GRASPING FORCEPS STR 20CM
AI 100-12	12	HALSTEAD-MOSQUITO HEMOST FCPS STR 12.5CM
AI 101-12	12	HALSTEAD-MOSQUITO HEMOST FCPS CVD 12.5CM
AI 140-16	6	RANKIN-CRILE HEMOSTATIC FORCEPS STR 16CM
AI 141-16	6	RANKIN-CRILE HEMOSTATIC FORCEPS CVD 16CM
AI 333-16	12	PEAN (ROCHESTER) HEMOSTAT FCPS CVD 16CM
AI 416-16	6	KOCHER HEMOSTATIC FORCEPS 1X2T STR 16CM
AK 151-08	12	BACKHAUS TOWEL FORCEPS 8CM
AK 151-13	12	BACKHAUS TOWEL FORCEPS 13CM
AL 200-25	6	FOERSTER SPONGE HOLD FCPS SERR STR 25CM
AN 510-21	1	DESCHAMPS LIGAT NEEDLE RIGHT CVD BL 21CM
AN 511-21	1	DESCHAMPS LIGAT NEEDLE LEFT CVD BL 21CM
AR 200-16	1	GOLD-GRIP MAYO-HEGAR NDHL P05 16CM
AR 200-18	1	GOLD-GRIP MAYO-HEGAR NDHL P05 18CM
AS 100-03	1	SCALPEL HANDLE NO 3 STANDARD
AS 100-04	1	SCALPEL HANDLE NO 4
AS 100-07	1	SCALPEL HANDLE NO 7
AT 200-00	1	YANKAUER SUCTION TUBE COMPLETE 27CM
AW 120-13	1	BUTTON-END PROBE W EYE DIA 2.0MM 13CM
AW 150-14	1	GROOVED DIRECTOR 14.5CM
AX 240-10	2	CUSHING RETRACTOR 10MM 20CM
AX 320-04	2	VOLKMANN RETRACTOR 4 PRONGS BLUNT 21.5CM
AX 320-06	2	VOLKMANN RETRACTOR 6 PRONGS BLUNT 21.5CM
AX 450-04	2	LANGENBECK RETRACTOR 40X11MM 21CM
AX 630-00	1	PARKER-LANGENBECK RETRACT SET #1-2 21CM
AX 650-02	1	DAVIDSON SCAP RETRACTOR 75X90 16CM
AX 680-01	2	RICHARDSON RETRACTOR 25X20MM 24CM
AX 680-02	2	RICHARDSON RETRACTOR 30X27MM 24CM
AX 680-03	2	RICHARDSON RETRACTOR 38X38MM 24CM
AX 790-02	2	HARRINGTON RETRACTOR 127X62MM 32CM
AX 800-08	2	DEAVER RETRACTOR 50MM 30CM
AX 910-30	1	ABDOMINAL SPATULA MALLEABLE 30MM 33CM
AX 910-40	2	ABDOMINAL SPATULA MALLEABLE 40MM 33CM
AZ 490-00	1	BALFOUR ABDOMINAL RETRACTOR COMPLETE
LA 120-34	1	BETHUNE RIB SHEAR 34CM
LA 590-00	1	TUFFIER RIB SPREADER STAINL STEEL 165MM
LA 620-01	1	FINOCHIETTO RIB SPREAD STAIN STEEL 165MM
LA 620-02	1	FINOCHIETTO RIB SPREAD STAIN STEEL 200MM
LA 620-03	1	FINOCHIETTO RIB SPREAD STAIN STEEL 250MM
LA 760-18	1	BAILEY RIB CONTRACTOR 18CM
MC 120-15	6	ALLIS INTESTINAL FORCEPS 5X6T 15CM

Artikel-Nr.	Menge quantity cantidad	Beschreibung Description descripción
MC 350-16	2	BABCOCK ATRAUMAT INTESTINAL FORCEPS 16CM
MC 410-20	2	COLLIN-DUVAL INTESTINAL FCPS 15MM 20CM
OD 330-15	1	FARABEUF PERIOST RASPATORY STR 13MM 15CM
OD 331-15	1	FARABEUF PERIOST RASPATORY CVD 13MM 15CM
OD 420-17	1	DOYEN RASPATORY F ADULTS BL L-CVD 17CM
OD 421-17	1	DOYEN RASPATORY F ADULTS BL R-CVD 17CM
OG 721-23	1	VAN BUREN BONE HOLDING FORCEPS 23CM
OR 551-23	1	STILLE-LUER BONE RONGEUR CVD 23CM
OR 701-27	1	STILLE-LISTON BONE CUT FCPS ANGL 27CM

## ZT 102-00

### Instrumenten-Set für die Ösophagus-Chirurgie Esophagectomy & Esophagus Replacement Set Set Esofagectomía y Reparación Esofágica

AD 510-23	1	GOLD-CUT MAYO DISSECT SCISS STR 23CM
AD 511-23	1	GOLD-CUT MAYO DISSECT SCISS CVD 23CM
AD 601-11	1	GOLD-CUT METZENBAUM SCISSOR CVD 11.5CM
AE 100-20	2	DRESSING FORCEPS STANDARD STR 20CM
AE 406-20	2	TISSUE FORCEPS 1X2T STR 20CM
AI 101-12	12	HALSTEAD-MOSQUITO HEMOST FCPS CVD 12.5CM
AI 131-14	12	CRILE HEMOSTATIC FORCEPS CVD 14CM
AI 333-16	12	PEAN (ROCHESTER) HEMOSTAT FCPS CVD 16CM
AI 333-20	6	PEAN (ROCHESTER) HEMOSTAT FCPS CVD 20CM
AI 416-20	6	KOCHER HEMOSTATIC FORCEPS 1X2T STR 20CM
AI 483-22	6	MIXTER DISSECTING CLAMP CVD 22CM
AK 151-08	12	BACKHAUS TOWEL FORCEPS 8CM
AR 270-26	2	GOLD-GRIP DEBAKEY NEEDLE HOLDER P04 26CM
AS 110-03	1	SCALPEL HANDLE NO 3L LONG
AX 390-04	2	ISRAEL RETRAC 4PRONGS BLUNT 40X40MM 25CM
LA 120-34	1	BETHUNE RIB SHEAR 34CM
LA 250-25	1	LEBSCHER STERNUM CHISEL 25CM
LA 520-02	1	FINOCHIETTO RIB SPREADER ALUMINIUM 135MM
LA 590-00	1	TUFFIER RIB SPREADER STAINL STEEL 165MM
LA 760-18	1	BAILEY RIB CONTRACTOR 18CM
LK 101-06	4	GLOVER ATRAUMATIC BULLDOG CLAMP CVD 6CM
MC 120-19	6	ALLIS INTESTINAL FORCEPS 5X6T 19CM
MC 190-20	2	ALLIS ATRAUMATIC INTESTINAL FORCEPS 20CM
MC 300-20	6	BABCOCK INTESTINAL TISSUE HOLD FCPS 20CM
MD 100-23	4	DOYEN INTESTINAL CLAMP STR 23CM
MD 200-25	2	KOCHER INTESTINAL CLAMP STR 25CM
OD 330-15	1	FARABEUF PERIOST RASPATORY STR 13MM 15CM
OD 420-17	1	DOYEN RASPATORY F ADULTS BL L-CVD 17CM
OD 421-17	1	DOYEN RASPATORY F ADULTS BL R-CVD 17CM
OD 900-02	1	WILLIGER MALLETT W LEAD FILLING 340G 24CM
OR 551-23	1	STILLE-LUER BONE RONGEUR CVD 23CM
OR 701-27	1	STILLE-LISTON BONE CUT FCPS ANGL 27CM

Artikel-Nr.	Menge quantity cantidad	Beschreibung Description descripción
-------------	-------------------------------	--

**ZT 103-00**

**Instrumenten-Grundset für Cardio-vasculäre Eingriffe  
Basic Cardiovascular Set  
Set Cardiovascular Básico**

AA 165-16	1	KELLY SURGICAL SCISSOR CVD 16CM
AA 201-20	1	METZENBAUM DISS SCISSOR BL/BL CVD 20CM
AB 217-99	1	DIETRICH VASCULAR SCISSOR 125DEG 18CM
AB 237-60	1	POTTS-SMITH VASCULAR SCISS 60DEG 19CM
AD 530-17	2	GOLD-CUT MAYO-STILLE SCISSOR STR 17CM
AD 531-17	2	GOLD-CUT MAYO-STILLE SCISSOR CVD 17CM
AD 551-18	1	GOLD-CUT METZENB SCISSOR BL/BL CVD 18CM
AD 551-20	1	GOLD-CUT METZENB SCISSOR BL/BL CVD 20CM
AD 810-12	2	GOLD-CUT UNIVER WIRE CUT SCS SERR 12,5CM
AE 160-12	1	ADSON DRESSING FORCEPS STR 12CM
AE 250-18	3	POTTS-SMITH DRESSING FCPS STR 18CM
AE 406-16	2	TISSUE FORCEPS 1X2T STR 16CM
AE 536-12	2	ADSON-BROWN TISSUE FORCEPS 9X9T 12CM
AE 806-15	2	RUSSIAN GRASPING FORCEPS STR 15CM
AE 806-20	2	RUSSIAN GRASPING FORCEPS STR 20CM
AF 810-20	4	DEBAKEY ATRAUM DRESS FCPS 2.0MM STR 20CM
AF 810-24	2	DEBAKEY ATRAUM DRESS FCPS 2.0MM STR 24CM
AI 100-12	1	HALSTEAD-MOSQUITO HEMOST FCPS STR 12.5CM
AI 101-12	6	HALSTEAD-MOSQUITO HEMOST FCPS CVD 12.5CM
AI 130-14	2	CRILE HEMOSTATIC FORCEPS STR 14CM
AI 131-14	12	CRILE HEMOSTATIC FORCEPS CVD 14CM
AI 181-18	3	ADSON HEMOSTATIC FORCEPS CVD 18.5CM
AI 221-20	10	HEISS HEMOSTATIC FORCEPS CVD 20CM
AI 241-24	3	CRAFOORD HEMOSTATIC FORCEPS CVD 24CM
AI 333-20	1	PEAN (ROCHESTER) HEMOSTAT FCPS CVD 20CM
AI 380-16	10	ROCHESTER-CARMALT HEMOSTAT FCPS STR 16CM
AI 416-16	10	KOCHER HEMOSTATIC FORCEPS 1X2T STR 16CM
AI 475-19	6	MIXTER DISSECTING CLAMP CVD 19CM
AK 151-08	6	BACKHAUS TOWEL FORCEPS 8CM
AK 151-13	6	BACKHAUS TOWEL FORCEPS 13CM
AL 200-25	8	FOERSTER SPONGE HOLD FCPS SERR STR 25CM
AR 200-16	3	GOLD-GRIP MAYO-HEGAR NDHL P05 16CM
AR 200-18	5	GOLD-GRIP MAYO-HEGAR NDHL P05 18CM
AR 200-20	3	GOLD-GRIP MAYO-HEGAR NDHL P05 20CM
AS 100-03	3	SCALPEL HANDLE NO 3 STANDARD
AS 110-03	1	SCALPEL HANDLE NO 3L LONG
AT 121-10	1	FRAZIER SUCTION TUBE 3.3MM 19CM
AT 171-08	1	POOLE SUCTION TUBE CURVED 8.0MM 22CM
AT 200-00	2	YANKAUER SUCTION TUBE COMPLETE 27CM
AX 154-03	4	SENN-MILLER RETRACTOR SHARP 20X6MM 16CM
AX 240-10	2	CUSHING RETRACTOR 10MM 20CM
AX 250-10	2	CUSHING RETRACTOR 10MM 24CM
AX 324-04	4	VOLKMANN RETRACTOR 4 PRONGS SHARP 21.5CM
AX 630-00	1	PARKER-LANGENBECK RETRACT SET #1-2 21CM
AX 680-01	2	RICHARDSON RETRACTOR 25X20MM 24CM
AX 680-02	2	RICHARDSON RETRACTOR 30X27MM 24CM
AX 680-03	2	RICHARDSON RETRACTOR 38X38MM 24CM
AX 680-04	2	RICHARDSON RETRACTOR 50X20MM 24CM
AX 800-04	2	DEAVER RETRACTOR 25MM 30CM
AX 800-08	2	DEAVER RETRACTOR 50MM 30CM
AX 800-09	2	DEAVER RETRACTOR 75MM 30CM
AX 910-30	1	ABDOMINAL SPATULA MALLEABLE 30MM 33CM

Artikel-Nr.	Menge quantity cantidad	Beschreibung Description descripción
-------------	-------------------------------	--

AX 910-40	1	ABDOMINAL SPATULA MALLEABLE 40MM 33CM
AX 910-50	1	ABDOMINAL SPATULA MALLEABLE 50MM 33CM
AZ 124-13	2	WEITLANER RETRACTOR 3X4T SHARP 13CM
AZ 270-18	2	GELPI SELF-RETAINING RETRACTOR 18CM
LA 250-25	1	LEBSCHE STERNUM CHISEL 25CM
MC 120-15	6	ALLIS INTESTINAL FORCEPS 5X6T 15CM
MC 120-19	3	ALLIS INTESTINAL FORCEPS 5X6T 19CM
MC 180-15	4	JUDD-ALLIS TISSUE HOLDING FCPS 3X4T 15CM
MC 300-16	4	BABCOCK INTESTINAL TISSUE HOLD FCPS 16CM
NC 370-20	1	ADSON DURAHOOK BLUNT 20CM
NC 374-20	2	ADSON DURAHOOK SHARP 20CM
OD 900-02	1	WILLIGER MALLETT W LEAD FILLING 340G 24CM

**ZT 104-00**

**Instrumenten-Grundset mit Vascularklemmen  
Vascular Forceps Set  
Set de Forcep Vascular**

AE 466-12	2	SEMKEN TISSUE FORCEPS 1X2T STR 12.5CM
AF 800-16	2	DEBAKEY ATRAUM DRESS FCPS 1.5MM STR 16CM
AF 810-20	2	DEBAKEY ATRAUM DRESS FCPS 2.0MM STR 20CM
AF 810-20	1	DEBAKEY ATRAUM DRESS FCPS 2.0MM STR 20CM
AF 810-24	2	DEBAKEY ATRAUM DRESS FCPS 2.0MM STR 24CM
AF 810-24	1	DEBAKEY ATRAUM DRESS FCPS 2.0MM STR 24CM
AH 100-15	2	GOLD-GRIP POTTS-SMITH FORCEPS STR 15CM
AH 100-20	2	GOLD-GRIP POTTS-SMITH FORCEPS STR 20CM
AH 420-12	1	GOLD-GRIP ADSON DISSECT FORCEPS STR 12CM
AI 031-65	1	JOHNS-HOPKINS BULLDOG CLAMP CVD 6.5CM
LK 050-07	2	DEBAKEY ATRAUMA BULLDOG CLAMP STR 7.5CM
LK 050-08	2	DEBAKEY ATRAUMA BULLDOG CLAMP STR 8.5CM
LK 050-10	4	DEBAKEY ATRAUMA BULLDOG CLAMP STR 10.5CM
LK 050-12	4	DEBAKEY ATRAUMA BULLDOG CLAMP STR 12CM
LK 220-23	1	POTTS ATRAUMATIC VASCULAR CLAMP STR 23CM
LK 571-19	2	LELAND-JONES ATRAUM VASC CLAMP 19CM
LK 461-24	1	WEBER ATRAUM AORTIC CLAMP LEFT CVD 24CM
LK 451-25	2	DEBAKEY-SATINSKY ATRAUMATIC CLAMP 25CM
LK 451-26	2	DEBAKEY-SATINSKY ATRAUMATIC CLAMP 26.5CM
LK 481-16	2	JAVID CAROTID SHUNT CLAMP 3.6MM 16CM
LK 523-17	2	DEBAKEY ATRAUMAT ANASTOMOSIS CLAMP 17CM
LK 581-15	2	COOLEY ATRAUM VASC CLAMP 30DEG 15CM
LK 583-15	2	COOLEY ATRAUM VASC CLAMP 60DEG 15CM

Artikel-Nr.	Menge quantity cantidad	Beschreibung Description descripción
-------------	-------------------------------	--

### ZT 107-00

#### Kleines Instrumenten Set für die Cardiovascular-Chirurgie Minor Cardiovascular Set Set Cardiovascular Menor

AA 201-14	2	METZENBAUM DISS SCISSOR BL/BL CVD
AF 800-16	1	DEBAKEY ATRAUM DRESS FCPS 1.5MM STR
AO 520-14	2	GOLD-GRIP CASTROV NH P02 W LOCK STR
AX 950-17	2	ABDOMINAL SPATULA MALLEABLE 17MM 20CM
LA 500-00	1	FINOCHIETTO-BABY RIB SPREADER ALU 75MM
LA 580-90	1	HAIGHT RIB SPREAD 30X30X90MM
LA 760-16	1	BAILEY-BABY RIB CONTRACTOR 16CM
LK 581-15	1	COOLEY ATRAUM VASC CLAMP 30DEG 15CM
LK 603-17	1	COOLEY ATRAUMATIC ANASTOMOSIS CLAMP
LK 621-16	1	COOLEY-DERRA ATRAUM ANASTOM CLAMP 16CM
LK 621-17	1	COOLEY-DERRA ATRAUM ANASTOM CLAMP 17CM
LK 621-18	1	COOLEY-DERRA ATRAUM ANASTOM CLAMP 18CM
OD 330-15	1	FARABEU PERIOST RASPATORY STR 13MM

### ZT 108-00

#### Instrumenten-Grundset für die Cardiovascular-Chirurgie Basic Cardiovascular Set Set Vascular Básico

AB 237-45	2	POTTS-SMITH VASCULAR SCISS 45DEG 19CM
AB 507-12	1	UNIVERSAL WIRE CUTTING SCISSOR SERR 12CM
AD 551-18	1	GOLD-CUT METZENB SCISSOR BL/BL CVD 18CM
AI 100-12	2	HALSTEAD-MOSQUITO HEMOST FCPS STR 12.5CM
AI 101-12	24	HALSTEAD-MOSQUITO HEMOST FCPS CVD 12.5CM
AK 151-08	12	BACKHAUS TOWEL FORCEPS 8CM
AL 200-25	1	FOERSTER SPONGE HOLD FCPS SERR STR 25CM
AR 220-15	3	GOLD-GRIP CRILE-WOOD NDHL P04 15CM
AR 220-18	1	GOLD-GRIP CRILE-WOOD NDHL P04 18CM
AR 220-20	1	GOLD-GRIP CRILE-WOOD NDHL P04 20CM
AT 200-00	1	YANKAUER SUCTION TUBE COMPLETE 27CM
AT 251-35	1	COOLEY SUCTION TUBE 8MM 35CM
AX 240-08	2	CUSHING RETRACTOR 8MM 20CM
AX 320-03	2	VOLKMANN RETRACTOR 3 PRONGS BLUNT 21.5CM
AX 324-03	2	VOLKMANN RETRACTOR 3 PRONGS SHARP 21.5CM
AX 670-00	2	RICHARDSON-EASTMAN RETRACTOR SET #1-2
LK 100-11	2	GLOVER ATRAUMATIC BULLDOG CLAMP STR 11CM
LK 231-26	1	DEBAKEY AORTIC ANEURYSM CLAMP CVD 26CM
LK 231-26	1	DEBAKEY AORTIC ANEURYSM CLAMP CVD 26CM
LK 241-21	1	DEBAKEY ATRAUMAT CLAMP ANGL 60DEG 21CM
LK 451-24	1	DEBAKEY-SATINSKY ATRAUMIC CLAMP 24CM
LK 500-21	2	GLOVER ATRAUM VASCULAR CLAMP STR 21CM
LK 500-21	2	GLOVER ATRAUM VASCULAR CLAMP STR 21CM
LK 571-18	2	LELAND-JONES ATRAUM VASC CLAMP ANGL 18CM
LK 603-17	2	COOLEY ATRAUMATIC ANASTOMOSIS CLAMP 17CM
LK 589-27	1	COOLEY ATRAUM RENAL ARTERY CLAMP 27CM
LK 593-22	2	COOLEY ATRAUMATIC ILIAC CLAMP 22CM

Artikel-Nr.	Menge quantity cantidad	Beschreibung Description descripción
-------------	-------------------------------	--

### ZT 109-00

#### Instrumenten-Set für die pädiatrische Thorakotomie Pediatric Thoractomy Set Set Toracotomía Pediátrico

AA 331-14	1	METZENB SCHERE FEIN ST/ST GEB 14,5CM
AD 551-18	1	GOLD-CUT METZENB SCISSOR BL/BL CVD 18CM
AE 406-15	2	TISSUE FORCEPS 1X2 TEETH 15CM
AI 101-12	12	HALSTEAD-MOSQUITO HEMOST FCPS CVD
AI 131-14	12	CRILE HEMOSTATIC FORCEPS CVD 14CM
AI 416-14	6	KOCHER HEMOSTATIC FORCEPS 1X2T STR 14CM
AI 451-14	6	BABY-MIXTER DISSECT CLAMP LIGHT CVD
AI 611-19	6	LAHEY GALL DUCT CLAMP CVD 19CM
AK 151-08	6	BACKHAUS TOWEL FORCEPS 8CM
AR 220-18	2	GOLD-GRIP CRILE-WOOD NDHL P04 18CM
AX 320-04	2	VOLKMANN RETRACTOR 4 PRONGS BLUNT
AX 420-01	2	KOCHER-LANGENBECK RETRACTOR 25X6MM 21CM
AX 800-02	2	DEAVER RETRACTOR 22MM 21.5CM
LA 500-00	1	FINOCHIETTO-BABY RIB SPREADER ALU 75MM
LA 520-01	1	FINOCHIETTO RIB SPREADER ALUMINIUM
LA 760-16	1	BAILEY-BABY RIB CONTRACTOR 16CM
OD 330-15	1	FARABEU PERIOST RASPATORY STR 13MM
OR 481-18	1	RUSKIN BONE RONGEUR CVD 18CM
OR 680-18	1	RUSKIN-LISTON BONE CUTTING FCPS STR

### ZT 111-00

#### Sinus-Set Sinus Set Set Cavidad Senos Frontales

AA 102-16	1	SURGICAL SCISSOR SH/BL STR 16.5CM
AA 201-18	1	METZENBAUM DISS SCISSOR BL/BL CVD 18CM
AE 100-16	1	DRESSING FORCEPS STANDARD STR 16CM
AE 100-18	1	DRESSING FORCEPS STANDARD STR 18CM
AE 406-14	1	TISSUE FORCEPS 1X2T STR 14.5CM
AI 130-14	3	CRILE HEMOSTATIC FORCEPS STR 14CM
AI 131-14	3	CRILE HEMOSTATIC FORCEPS CVD 14CM
AK 151-11	6	BACKHAUS TOWEL FORCEPS 11CM
AL 200-18	1	FOERSTER SPONGE HOLD FCPS SERR STR 18CM
AN 300-18	1	MAYO-HEGAR NEEDLE HOLDER 18CM
AS 100-03	3	SCALPEL HANDLE NO 3 STANDARD
AT 121-08	1	FRAZIER SUCTION TUBE 2.7MM 19CM
AT 121-11	1	FRAZIER SUCTION TUBE 11 FR
AT 200-00	1	YANKAUER SUCTION TUBE COMPLETE 27CM
AU 110-04	1	STANDARD TROCAR DIA 4MM / 3MM 18CM
AX 154-03	1	SENN-MILLER RETRACTOR SHARP 20X6MM 16CM
AX 602-01	1	ROUX-MAGNUS RETRACTOR 25X29MM
AX 665-00	1	FARABEU RETRACTOR SET #1-2 12CM
HH 311-19	1	FREER SEPTUM ELEVAT SHARP 19CM
HK 470-03	1	HAJEK-KOFLER ANTRUM PUNCH UP 3.5X3.5MM
HK 472-03	1	HAJEK-KOFLER ANTRUM PUNCH DOWN
HO 855-01	1	LUCAE EAR HOOK #1 14CM
OD 262-04	1	ALEXANDER CHISEL 4MM 18CM
OD 262-06	1	ALEXANDER CHISEL 6MM 18CM

Artikel-Nr.	Menge quantity cantidad	Beschreibung Description descripción
OD 264-04	1	ALEXANDER GOUGE 4MM 18CM
OD 264-06	1	ALEXANDER GOUGE 6MM 18CM
OD 511-17	1	ADSON PERIOST ELEVATOR CVD 7MM 17CM
OD 611-05	1	BRUNS BONE CURETTE ROUND #1 17CM
OD 611-06	1	BRUNS BONE CURETTE ROUND #2 17CM
OD 611-07	1	BRUNS BONE CURETTE ROUND #3 17CM
OD 990-18	1	MALLET W PLASTIC FACES 220G 18.5CM

### ZT 112-00

#### Thorax- und Peripheral-Instrumenten-Set Thoracic and Peripheral Set Set Toracosentesis Periférica

AA 650-15	1	REYNOLDS DISSECTING SCISSOR STR 15CM
AB 237-45	1	POTTS-SMITH VASCULAR SCISS 45DEG 19CM
AB 621-20	2	WERTHEIM GYNEC SCISSOR BL/BL CVD 14.5CM
AD 511-23	1	GOLD-CUT MAYO DISSECT SCISS CVD 23CM
AD 550-25	1	GOLD-CUT METZENB SCISSOR BL/BL STR 25CM
AI 230-24	6	SAROT HEMOSTATIC FORCEPS STR 24CM
AI 483-22	2	MIXTER DISSECTING CLAMP CVD 22CM
AI 485-23	2	MIXTER DISSECTING CLAMP CVD 23CM
AT 121-12	1	FRAZIER SUCTION TUBE 4.0MM 19CM
AT 171-05	1	POOLE SUCTION TUBE CURVED 5.5MM 20CM
AT 200-00	1	YANKAUER SUCTION TUBE COMPLETE 27CM
AZ 270-18	2	GELPI SELF-RETAINING RETRACTOR 18CM
LA 620-02	1	FINOCHIETTO RIB SPREAD STAIN STEEL
LK 050-08	2	DEBAKEY ATRAUMA BULLDOG CLAMP STR 8.5CM
LK 050-10	2	DEBAKEY ATRAUMA BULLDOG CLAMP STR
LK 051-10	2	DEBAKEY ATRAUMA BULLDOG CLAMP CVD
LK 051-08	2	DEBAKEY ATRAUMA BULLDOG CLAMP CVD 8.5CM
LK 241-21	1	DEBAKEY ATRAUMAT CLAMP ANGL 60DEG 21CM
LK 261-24	2	DEBAKEY-BAHNSON ANEURYSM CLAMP 24CM
LK 321-16	4	DEBAKEY ATRAUM PERIPHERAL CLAMP CVD
LK 500-21	1	GLOVER ATRAUM VASCULAR CLAMP STR 21CM
LK 509-22	1	GLOVER ATRAUM VASCULAR CLAMP CVD 21CM
LK 589-18	1	COOLEY ATRAUM RENAL ARTERY CLAMP 18.5CM
LK 593-22	2	COOLEY ATRAUMATIC ILIAC CLAMP 22CM
LK 603-17	1	COOLEY ATRAUMATIC ANASTOMOSIS CLAMP
LK 621-17	2	COOLEY-DERRA ATRAUM ANASTOM CLAMP 17CM
LK 631-15	2	COOLEY-BECK ATRAUMAT VASCULAR CLAMP
LM 101-27	1	SATINSKY VENA CAVA CL CROSS SERR 27.5CM
MC 120-19	6	ALLIS INTESTINAL FORCEPS 5X6T 19CM

Artikel-Nr.	Menge quantity cantidad	Beschreibung Description descripción
-------------	-------------------------------	--

### ZT 113-00

#### Instrumenten-Set für die Therapie des Herzstillstandes Cardiac Arrest Set Set Paro Cardiaco

AD 510-17	1	GOLD-CUT MAYO DISSECT SCISS STR 17CM
AD 511-17	1	GOLD-CUT MAYO DISSECT SCISS CVD 17CM
AD 551-28	1	GOLD-CUT METZENB SCISSOR BL/BL CVD 28CM
AE 100-13	2	DRESSING FORCEPS STANDARD STR 13CM
AE 406-13	2	TISSUE FORCEPS 1X2T STR 13CM
AE 486-12	2	ADSON TISSUE FORCEPS 1X2T STR 12CM
AI 141-16	6	RANKIN-CRILE HEMOSTATIC FORCEPS CVD
AI 230-24	2	SAROT HEMOSTATIC FORCEPS STR 24CM
AL 200-25	2	FOERSTER SPONGE HOLD FCPS SERR STR 25CM
AR 220-20	2	GOLD-GRIP CRILE-WOOD NDHL P04 20CM
AS 100-03	1	SCALPEL HANDLE NO 3 STANDARD
LA 590-00	1	TUFFIER RIB SPREADER STAINL STEEL 165MM
LA 760-18	1	BAILEY RIB CONTRACTOR 18CM
LK 500-22	1	GLOVER ATRAUM VASCULAR CLAMP STR 22CM
LK 621-17	1	COOLEY-DERRA ATRAUM ANASTOM CLAMP 17CM

### ZT 114-00

#### Vasculares Instrumenten-Set für Erwachsene Vascular Set for adult Set Vascular Adulto

AB 237-45	2	POTTS-SMITH VASCULAR SCISS 45DEG 19CM
AB 507-12	1	UNIVERSAL WIRE CUTTING SCISSOR SERR
AD 551-28	1	GOLD-CUT METZENB SCISSOR BL/BL CVD 28CM
AI 100-12	2	HALSTEAD-MOSQUITO HEMOST FCPS STR
AI 101-12	24	HALSTEAD-MOSQUITO HEMOST FCPS CVD
AK 151-08	12	BACKHAUS TOWEL FORCEPS 8CM
AL 201-25	1	FOERSTER SPONGE HOLD FCPS SERR CVD 25CM
AR 220-15	3	GOLD-GRIP CRILE-WOOD NDHL P04 15CM
AR 220-18	1	GOLD-GRIP CRILE-WOOD NDHL P04 18CM
AR 220-20	1	GOLD-GRIP CRILE-WOOD NDHL P04 20CM
AT 200-00	1	YANKAUER SUCTION TUBE COMPLETE 27CM
AT 251-35	1	COOLEY SUCTION TUBE 8MM 35CM
AT 281-33	1	COOLEY SUCTION TUBE 8MM 33CM
AX 250-08	2	CUSHING RETRACTOR 8MM 24CM
AX 320-03	2	VOLKMANN RETRACTOR 3 PRONGS BLUNT
AX 324-03	2	VOLKMANN RETRACTOR 3 PRONGS SHARP
AX 670-00	2	RICHARDSON-EASTMAN RETRACTOR SET #1-2
LK 100-11	2	GLOVER ATRAUMATIC BULLDOG CLAMP STR
LK 241-21	1	DEBAKEY ATRAUMAT CLAMP ANGL 60DEG 21CM
LK 251-23	1	DEBAKEY-SEMB ATRAUM LIGAT CLAMP23.5CM
LK 261-25	1	DEBAKEY-BAHNSON ANEURYSM CLAMP 25CM
LK 411-25	1	MORRIS-DEBAKEY ATRAUM AORT CLAMP 25CM
LK 451-24	1	DEBAKEY-SATINSKY ATRAUMIC CLAMP 24CM
LK 500-22	2	GLOVER ATRAUM VASCULAR CLAMP STR 22CM
LK 571-18	2	LELAND-JONES ATRAUM VASC CLAMP ANGL
LK 581-15	1	COOLEY ATRAUM VASC CLAMP 30DEG 15CM
LK 589-27	1	COOLEY ATRAUM RENAL ARTERY CLAMP 27CM
LK 593-22	2	COOLEY ATRAUMATIC ILIAC CLAMP 22CM
LK 500-21	2	GLOVER ATRAUM VASCULAR CLAMP STR 21CM
LK 621-17	2	COOLEY-DERRA ATRAUM ANASTOM CLAMP 17CM

Artikel-Nr.	Menge quantity cantidad	Beschreibung Description descripción
-------------	-------------------------------	--

### ZT 115-00

#### Vasculäres-Set für die Pädiatrie

#### Pediatric Vascular Set

#### Set Vascular Pediátrico

LK 491-17	1	DALE ATRAUMATIC PERIPHER CLAMP CVD 17CM
LK 493-18	1	DALE ATRAUMATIC PERIPHER CLAMP CVD 18CM
LK 521-17	1	DEBAKEY ATRAUMAT ANASTOMOSIS CLAMP 17CM
LK 523-16	1	DEBAKEY ATRAUMAT ANASTOMOSIS CLAMP 16CM
LK 523-17	1	DEBAKEY ATRAUMAT ANASTOMOSIS CLAMP 17CM
LK 581-15	1	COOLEY ATRAUM VASC CLAMP 30DEG 15CM
LK 585-13	1	COOLEY ATRAUM VASC CLAMP 90DEG 13CM
LK 589-22	1	COOLEY ATRAUM RENAL ARTERY CLAMP 22CM
LK 603-17	1	COOLEY ATRAUMATIC ANASTOMOSIS CLAMP
LK 621-17	1	COOLEY-DERRA ATRAUM ANASTOM CLAMP 17CM
LK 631-15	2	COOLEY-BECK ATRAUMAT VASCULAR CLAMP
LK 903-14	1	COOLEY ATRAUM PEDIATRIC CLAMP SPOON
LK 907-14	2	COOLEY ATRAUM PEDIATRIC CLAMP ANGL 14CM

### ZT 116-00

#### Pleurotomie-Set

#### Pleurotomy Set

#### Pleurotomía

AA 171-17	1	MAYO DISSECTING SCISSOR CVD 17CM
AE 486-12	2	ADSON TISSUE FORCEPS 1X2T STR 12CM
AI 141-16	1	RANKIN-CRILE HEMOSTATIC FORCEPS CVD
AI 220-20	2	HEISS HEMOSTATIC FORCEPS STR 20CM
AL 200-25	1	FOERSTER SPONGE HOLD FCPS SERR STR 25CM
AN 310-20	1	MAYO-HEGAR NEEDLE HOLD FINE PATTERN
AS 100-03	1	SCALPEL HANDLE NO 3 STANDARD

### ZT 118-00

#### Instrumenten-Set für den koronaren Bypass

#### Coronary Bypass Set

#### Set Bypass Coronario

AA 650-15	1	REYNOLDS DISSECTING SCISSOR STR 15CM
AB 217-25	1	DIETRICH VASCULAR SCISSOR 25DEG 18CM
AB 217-45	1	DIETRICH VASCULAR SCISSOR 45DEG 18CM
AB 217-60	1	DIETRICH VASCULAR SCISSOR 60DEG 18CM
AB 217-90	1	DIETRICH VASCULAR SCISSOR 90DEG 18CM
AB 217-99	1	DIETRICH VASCULAR SCISSOR 125DEG 18CM
AF 800-16	2	DEBAKEY ATRAUM DRESS FCPS 1.5MM STR
AF 800-20	2	DEBAKEY ATRAUM DRESS FCPS 1.5MM STR
AF 800-20	1	DEBAKEY ATRAUM DRESS FCPS 1.5MM STR
AF 810-24	2	DEBAKEY ATRAUM DRESS FCPS 2.0MM STR
AI 080-10	6	HARTMANN HEMOSTATIC FORCEPS STR 10CM
AI 080-10	6	HARTMANN HEMOSTATIC FORCEPS STR 10CM
AI 475-19	2	MIXTER DISSECTING CLAMP CVD 19CM
AR 280-15	1	GOLD-GRIP MINI RYDER NDHL P02 15CM
AR 300-15	1	GOLD-GRIP RYDER NEEDLE HOLDER STR 15CM
AR 300-18	1	GOLD-GRIP RYDER NEEDLE HOLDER STR 18CM
MK 420-01	1	BAKES GALL DUCT DILAT MALLEABLE 1MM

Artikel-Nr.	Menge quantity cantidad	Beschreibung Description descripción
-------------	-------------------------------	--

MK 420-02	1	BAKES GALL DUCT DILAT MALLEABLE 2MM
MK 420-03	1	BAKES GALL DUCT DILAT MALLEABLE 3MM
MK 420-04	1	BAKES GALL DUCT DILAT MALLEABLE 4MM
MK 420-05	1	BAKES GALL DUCT DILAT MALLEABLE 5MM
MK 420-06	1	BAKES GALL DUCT DILAT MALLEABLE 6MM
MK 420-07	1	BAKES GALL DUCT DILAT MALLEABLE 7MM
MK 420-08	1	BAKES GALL DUCT DILAT MALLEABLE 8MM
MK 420-09	1	BAKES GALL DUCT DILAT MALLEABLE 9MM
MK 420-10	1	BAKES GALL DUCT DILAT MALLEABLE 10MM
MK 420-11	1	BAKES GALL DUCT DILAT MALLEABLE 11MM

### ZT 119-00

#### Endarterektomie-Set

#### Endarterectomy Set

#### Set Endarterectomía

AA 144-11	1	IRIS SCISSOR SH/SH STR 11.5CM
AA 145-11	1	IRIS SCISSOR SH/SH CVD 11.5CM
AA 180-17	1	MAYO-STILLE DISSECT SCISSOR STR 17CM
AA 181-17	1	MAYO-STILLE DISSECT SCISSOR CVD 17CM
AA 201-18	1	METZENBAUM DISS SCISSOR BL/BL CVD 18CM
AB 237-45	1	POTTS-SMITH VASCULAR SCISS 45DEG 19CM
AE 100-14	2	DRESSING FORCEPS STANDARD STR 14.5CM
AE 160-12	2	ADSON DRESSING FORCEPS STR 12CM
AE 406-14	2	TISSUE FORCEPS 1X2T STR 14.5CM
AE 486-12	2	ADSON TISSUE FORCEPS 1X2T STR 12CM
AI 101-12	8	HALSTEAD-MOSQUITO HEMOST FCPS CVD
AI 131-14	8	CRILE HEMOSTATIC FORCEPS CVD 14CM
AI 333-16	4	PEAN (ROCHESTER) HEMOSTAT FCPS CVD 16CM
AI 451-18	2	BABY-MIXTER DISSECT CLAMP LIGHT CVD
AK 151-13	4	BACKHAUS TOWEL FORCEPS 13CM
AL 200-25	2	FOERSTER SPONGE HOLD FCPS SERR STR 25CM
AN 244-15	2	CRILE-WOOD NEEDLE HOLDER 15CM
AS 100-03	1	SCALPEL HANDLE NO 3 STANDARD
AT 121-10	2	FRAZIER SUCTION TUBE 3.3MM 19CM
AW 120-13	2	BUTTON-END PROBE W EYE DIA 2.0MM 13CM
AX 240-08	2	CUSHING RETRACTOR 8MM 20CM
AX 520-02	2	MIDDELDORPF RETRACTOR 22X21MM 22CM
AX 630-00	1	PARKER-LANGENBECK RETRACT SET #1-2 21CM
AX 680-01	2	RICHARDSON RETRACTOR 25X20MM 24CM
LK 101-06	2	GLOVER ATRAUMATIC BULLDOG CLAMP CVD 6CM
LK 101-07	2	GLOVER ATRAUMATIC BULLDOG CLAMP CVD 7CM
LK 101-09	2	GLOVER ATRAUMATIC BULLDOG CLAMP CVD 9CM
MC 120-15	4	ALLIS INTESTINAL FORCEPS 5X6T 15CM



Artikel-Nr.	Menge quantity cantidad	Beschreibung Description descripción
-------------	-------------------------------	--

## ZT 120-00

### Instrumenten-Set für de Unterbindung der Vena Saphena Saphenous Vein Ligation Set Set Ligadura de Vena Safena

AA 102-14	2	SURGICAL SCISSOR SH/BL STR 14.5CM
AA 170-17	1	MAYO DISSECTING SCISSOR STR 17CM
AA 201-18	1	METZENBAUM DISS SCISSOR BL/BL CVD 18CM
AE 100-14	2	DRESSING FORCEPS STANDARD STR 14.5CM
AE 406-14	1	TISSUE FORCEPS 1X2T STR 14.5CM
AI 100-12	4	HALSTEAD-MOSQUITO HEMOST FCPS STR
AI 101-12	4	HALSTEAD-MOSQUITO HEMOST FCPS CVD
AI 141-16	2	RANKIN-CRILE HEMOSTATIC FORCEPS CVD
AK 151-08	8	BACKHAUS TOWEL FORCEPS 8CM
AK 151-13	4	BACKHAUS TOWEL FORCEPS 13CM
AL 200-25	4	FOERSTER SPONGE HOLD FCPS SERR STR 25CM
AN 244-15	2	CRILE-WOOD NEEDLE HOLDER 15CM
AN 300-16	3	MAYO-HEGAR NEEDLE HOLDER 16CM
AN 300-18	1	MAYO-HEGAR NEEDLE HOLDER 18CM
AN 300-18	5	MAYO-HEGAR NEEDLE HOLDER 18CM
AN 300-20	3	MAYO-HEGAR NEEDLE HOLDER 20CM
AN 510-21	1	DESCHAMPS LIGAT NEEDLE RIGHT CVD BL
AN 651-01	1	KOENIG LIGATURE CONDUCT 2.8MM CVD
AS 100-03	1	SCALPEL HANDLE NO 3 STANDARD
AS 100-04	1	SCALPEL HANDLE NO 4
AT 121-10	1	FRAZIER SUCTION TUBE 3.3MM 19CM
AT 121-10	1	FRAZIER SUCTION TUBE 3.3MM 19CM
AT 171-08	1	POOLE SUCTION TUBE CURVED 8.0MM 22CM
AT 200-00	2	YANKAUER SUCTION TUBE COMPLETE 27CM
AT 200-00	2	YANKAUER SUCTION TUBE COMPLETE 27CM
AT 271-30	1	COOLEY SUCTION TUBE 6MM 30CM
AT 281-33	1	COOLEY SUCTION TUBE 8MM 33CM
AW 120-13	1	BUTTON-END PROBE W EYE DIA 2.0MM 13CM
AX 154-03	4	SENN-MILLER RETRACTOR SHARP 20X6MM 16CM
AX 240-08	2	CUSHING RETRACTOR 8MM 20CM
AX 240-10	2	CUSHING RETRACTOR 10MM 20CM
AX 240-10	2	CUSHING RETRACTOR 10MM 20CM
AX 320-03	2	VOLKMANN RETRACTOR 3 PRONGS BLUNT
AX 324-04	4	VOLKMANN RETRACTOR 4 PRONGS SHARP
AX 520-01	2	MIDDELDORPF RETRACTOR 16X14MM 21.5CM
AX 600-00	1	ROUX RETRACTOR SET #1-3 16.5CM
AX 630-00	1	PARKER-LANGENBECK RETRACT SET #1-2 21CM
AX 665-00	1	FARABEUF RETRACTOR SET #1-2 12CM
AX 680-01	2	RICHARDSON RETRACTOR 25X20MM 24CM
AX 680-02	2	RICHARDSON RETRACTOR 30X27MM 24CM
AX 680-03	2	RICHARDSON RETRACTOR 38X38MM 24CM
AX 680-04	2	RICHARDSON RETRACTOR 50X20MM 24CM
AX 800-04	2	DEAVER RETRACTOR 25MM 30CM
AX 800-08	1	DEAVER RETRACTOR 50MM 30CM
AX 800-09	2	DEAVER RETRACTOR 75MM 30CM
AX 910-30	1	ABDOMINAL SPATULA MALLEABLE 30MM 33CM
AX 910-40	1	ABDOMINAL SPATULA MALLEABLE 40MM 33CM
AX 910-50	1	ABDOMINAL SPATULA MALLEABLE 50MM 33CM
AZ 114-13	2	WULLSTEIN-WEITLANER RETRACT 3X3T SH
AZ 124-16	1	WEITLANER RETRACTOR 3X4T SHARP 16.5CM
AZ 275-18	2	GELPI SELF RETAINING RETRAC W BALLS

Artikel-Nr.	Menge quantity cantidad	Beschreibung Description descripción
-------------	-------------------------------	--

LA 250-25	1	LEBSCHER STERNUM CHISEL 25CM
LD 250-00	1	NABATOFF VARICOSE VEIN STRIPPER SET
MC 120-15	2	ALLIS INTESTINAL FORCEPS 5X6T 15CM
OD 700-02	1	WILLIGER BONE CURETTE OVAL #00/0 13.5CM

## ZT 121-00

### Instrumenten-Set für die chirurgische Versorgung von Ventrikelseptumdefekten Ventricular Septal Defect Repair Set Set de Reparación Defecto Septo Ventricular

AA 165-16	1	KELLY SURGICAL SCISSOR CVD 16CM
AA 180-17	2	MAYO-STILLE DISSECT SCISSOR STR 17CM
AA 181-17	2	MAYO-STILLE DISSECT SCISSOR CVD 17CM
AA 201-18	1	METZENBAUM DISS SCISSOR BL/BL CVD 18CM
AA 201-20	1	METZENBAUM DISS SCISSOR BL/BL CVD 20CM
AB 237-25	1	POTTS-SMITH VASCULAR SCIASS 25DEG 19CM
AB 237-45	1	POTTS-SMITH VASCULAR SCIASS 45DEG 19CM
AD 551-20	1	GOLD-CUT METZENB SCISSOR BL/BL CVD 20CM
AD 810-12	2	GOLD-CUT UNIVER WIRE CUT SCS SERR
AE 160-12	1	ADSON DRESSING FORCEPS STR 12CM
AE 250-18	3	POTTS-SMITH DRESSING FCPS STR 18CM
AE 406-14	2	TISSUE FORCEPS 1X2T STR 14.5CM
AE 536-12	2	ADSON-BROWN TISSUE FORCEPS 9X9T 12CM
AE 806-15	2	RUSSIAN GRASPING FORCEPS STR 15CM
AE 806-20	2	RUSSIAN GRASPING FORCEPS STR 20CM
AF 810-20	4	DEBAKEY ATRAUM DRESS FCPS 2.0MM STR
AF 810-24	2	DEBAKEY ATRAUM DRESS FCPS 2.0MM STR
AI 100-12	1	HALSTEAD-MOSQUITO HEMOST FCPS STR
AI 101-12	6	HALSTEAD-MOSQUITO HEMOST FCPS CVD
AI 130-14	2	CRILE HEMOSTATIC FORCEPS STR 14CM
AI 131-14	12	CRILE HEMOSTATIC FORCEPS CVD 14CM
AI 181-18	3	ADSON HEMOSTATIC FORCEPS CVD 18.5CM
AI 221-20	10	HEISS HEMOSTATIC FORCEPS CVD 20CM
AI 241-24	3	CRAFOORD HEMOSTATIC FORCEPS CVD 24CM
AI 333-20	1	PEAN (ROCHESTER) HEMOSTAT FCPS CVD 20CM
AI 380-16	10	ROCHESTER-CARMALT HEMOSTAT FCPS STR
AI 416-16	10	KOCHER HEMOSTATIC FORCEPS 1X2T STR 16CM
AI 475-19	3	MIXTER DISSECTING CLAMP CVD 19CM
AK 151-08	6	BACKHAUS TOWEL FORCEPS 8CM
AK 151-13	6	BACKHAUS TOWEL FORCEPS 13CM
AL 200-25	8	FOERSTER SPONGE HOLD FCPS SERR STR 25CM
AS 100-03	6	SCALPEL HANDLE NO 3 STANDARD
AS 110-03	6	SCALPEL HANDLE NO 3L LONG
MC 120-15	6	ALLIS INTESTINAL FORCEPS 5X6T 15CM
MC 120-19	3	ALLIS INTESTINAL FORCEPS 5X6T 19CM
MC 150-15	4	ALLIS-ADAIR INTESTINAL FCPS 10X11T 15CM
MC 300-16	4	BABCOCK INTESTINAL TISSUE HOLD FCPS

Artikel-Nr.	Menge quantity cantidad	Beschreibung Description descripción
-------------	-------------------------------	--

## ZT 122-00

### Instrumenten-Set für die chirurgische Versorgung von atrialen Septumdefekten Atrial Septal Defect Repair Set Set de Reparación Defecto Septal Atrial

AA 165-16	1	KELLY SURGICAL SCISSOR CVD 16CM
AA 180-17	2	MAYO-STILLE DISSECT SCISSOR STR 17CM
AA 181-17	2	MAYO-STILLE DISSECT SCISSOR CVD 17CM
AA 201-18	1	METZENBAUM DISS SCISSOR BL/BL CVD 18CM
AA 201-20	1	METZENBAUM DISS SCISSOR BL/BL CVD 20CM
AB 237-25	1	POTTS-SMITH VASCULAR SCIASS 25DEG 19CM
AB 237-45	1	POTTS-SMITH VASCULAR SCIASS 45DEG 19CM
AD 551-20	1	GOLD-CUT METZENB SCISSOR BL/BL CVD 20CM
AD 810-12	2	GOLD-CUT UNIVER WIRE CUT SCS SERR
AE 160-12	1	ADSON DRESSING FORCEPS STR 12CM
AE 250-18	3	POTTS-SMITH DRESSING FCPS STR 18CM
AE 406-14	2	TISSUE FORCEPS 1X2T STR 14.5CM
AE 536-12	2	ADSON-BROWN TISSUE FORCEPS 9X9T 12CM
AE 806-15	2	RUSSIAN GRASPING FORCEPS STR 15CM
AE 806-20	2	RUSSIAN GRASPING FORCEPS STR 20CM
AF 810-20	4	DEBAKEY ATRAUM DRESS FCPS 2.0MM STR
AF 810-24	2	DEBAKEY ATRAUM DRESS FCPS 2.0MM STR
AI 100-12	1	HALSTEAD-MOSQUITO HEMOST FCPS STR
AI 101-12	6	HALSTEAD-MOSQUITO HEMOST FCPS CVD
AI 130-14	2	CRILE HEMOSTATIC FORCEPS STR 14CM
AI 131-14	12	CRILE HEMOSTATIC FORCEPS CVD 14CM
AI 181-18	3	ADSON HEMOSTATIC FORCEPS CVD 18.5CM
AI 221-20	10	HEISS HEMOSTATIC FORCEPS CVD 20CM
AI 241-24	3	CRAFOORD HEMOSTATIC FORCEPS CVD 24CM
AI 333-20	1	PEAN (ROCHESTER) HEMOSTAT FCPS CVD 20CM
AI 380-16	10	ROCHESTER-CARMALT HEMOSTAT FCPS STR
AI 416-16	10	KOCHER HEMOSTATIC FORCEPS 1X2T STR 16CM
AI 475-19	6	MIXTER DISSECTING CLAMP CVD 19CM
AK 151-08	6	BACKHAUS TOWEL FORCEPS 8CM
AK 151-13	6	BACKHAUS TOWEL FORCEPS 13CM
AL 200-25	8	FOERSTER SPONGE HOLD FCPS SERR STR 25CM
AN 300-16	3	MAYO-HEGAR NEEDLE HOLDER 16CM
AN 300-18	5	MAYO-HEGAR NEEDLE HOLDER 18CM
AN 300-20	3	MAYO-HEGAR NEEDLE HOLDER 20CM
AS 100-03	6	SCALPEL HANDLE NO 3 STANDARD
AS 110-03	6	SCALPEL HANDLE NO 3L LONG
AT 121-10	1	FRAZIER SUCTION TUBE 3.3MM 19CM
AT 171-08	1	POOLE SUCTION TUBE CURVED 8.0MM 22CM
AT 200-00	2	YANKAUER SUCTION TUBE COMPLETE 27CM
AT 200-00	2	YANKAUER SUCTION TUBE COMPLETE 27CM
AT 271-30	1	COOLEY SUCTION TUBE 6MM 30CM
AT 281-33	1	COOLEY SUCTION TUBE 8MM 33CM
AX 154-03	4	SENN-MILLER RETRACTOR SHARP 20X6MM 16CM
AX 240-08	2	CUSHING RETRACTOR 8MM 20CM
AX 240-10	2	CUSHING RETRACTOR 10MM 20CM
AX 324-04	4	VOLKMANN RETRACTOR 4 PRONGS SHARP
AX 520-01	2	MIDDELDORPF RETRACTOR 16X14MM 21.5CM
AX 610-00	1	PARKER RETRACTOR SET #1-2 14CM
AX 630-00	1	PARKER-LANGBECK RETRACT SET #1-2 21CM
AX 680-01	2	RICHARDSON RETRACTOR 25X20MM 24CM
AX 680-02	2	RICHARDSON RETRACTOR 30X27MM 24CM

Artikel-Nr.	Menge quantity cantidad	Beschreibung Description descripción
-------------	-------------------------------	--

AX 680-03	2	RICHARDSON RETRACTOR 38X38MM 24CM
AX 680-04	2	RICHARDSON RETRACTOR 50X20MM 24CM
AX 800-04	2	DEAVER RETRACTOR 25MM 30CM
AX 800-08	1	DEAVER RETRACTOR 50MM 30CM
AX 800-09	2	DEAVER RETRACTOR 75MM 30CM
AX 910-30	1	ABDOMINAL SPATULA MALLEABLE 30MM 33CM
AX 910-40	1	ABDOMINAL SPATULA MALLEABLE 40MM 33CM
AX 910-50	1	ABDOMINAL SPATULA MALLEABLE 50MM 33CM
AZ 124-13	2	WEITLANER RETRACTOR 3X4T SHARP 13CM
AZ 270-18	2	GELPI SELF-RETAINING RETRACTOR 18CM
LA 250-25	1	LEBSCHER STERNUM CHISEL 25CM
MC 120-15	6	ALLIS INTESTINAL FORCEPS 5X6T 15CM
MC 120-19	3	ALLIS INTESTINAL FORCEPS 5X6T 19CM
MC 150-15	4	ALLIS-ADAIR INTESTINAL FCPS 10X11T 15CM
MC 300-16	4	BABCOCK INTESTINAL TISSUE HOLD FCPS
OD 900-02	1	WILLIGER MALLEABLE W LEAD FILLING 340G

## ZT 124-00

### Instrumenten Set für die offene Thorakotomie Open Thoracotomy Set Set Toracotomía Abierta

LA 220-27	1	GIERTZ-STILLE RIB SHEAR 27CM
LA 233-32	1	BRUNNER RIB SHEARS LE HAND
LA 231-32	1	BRUNNER RIB SHEARS RI HAND
OD 330-15	1	FARABEUF PERIOST RASPATORY STR 13MM

## ZT 125-00

### Thoracotomie-Set für die geschlossene Herzchirurgie Thoracotomy Set for closed Heart procedure Set de Toracotomía para Cierre Procedimiento Cardiaco

AA 165-16	1	KELLY SURGICAL SCISSOR CVD 16CM
AA 180-17	2	MAYO-STILLE DISSECT SCISSOR STR 17CM
AA 181-17	2	MAYO-STILLE DISSECT SCISSOR CVD 17CM
AA 201-18	1	METZENBAUM DISS SCISSOR BL/BL CVD 18CM
AA 201-20	1	METZENBAUM DISS SCISSOR BL/BL CVD 20CM
AB 237-25	1	POTTS-SMITH VASCULAR SCIASS 25DEG 19CM
AB 237-45	1	POTTS-SMITH VASCULAR SCIASS 45DEG 19CM
AD 551-20	1	GOLD-CUT METZENB SCISSOR BL/BL CVD 20CM
AD 810-12	2	GOLD-CUT UNIVER WIRE CUT SCS SERR
AE 160-12	1	ADSON DRESSING FORCEPS STR 12CM
AE 250-18	3	POTTS-SMITH DRESSING FCPS STR 18CM
AE 406-14	2	TISSUE FORCEPS 1X2T STR 14.5CM
AE 536-12	2	ADSON-BROWN TISSUE FORCEPS 9X9T 12CM
AE 806-15	2	RUSSIAN GRASPING FORCEPS STR 15CM
AE 806-20	2	RUSSIAN GRASPING FORCEPS STR 20CM
AF 810-20	4	DEBAKEY ATRAUM DRESS FCPS 2.0MM STR
AF 810-24	2	DEBAKEY ATRAUM DRESS FCPS 2.0MM STR
AI 100-12	1	HALSTEAD-MOSQUITO HEMOST FCPS STR
AI 101-12	6	HALSTEAD-MOSQUITO HEMOST FCPS CVD
AI 130-14	2	CRILE HEMOSTATIC FORCEPS STR 14CM
AI 131-14	12	CRILE HEMOSTATIC FORCEPS CVD 14CM
AI 181-18	3	ADSON HEMOSTATIC FORCEPS CVD 18.5CM
AI 221-20	10	HEISS HEMOSTATIC FORCEPS CVD 20CM
AI 241-24	3	CRAFOORD HEMOSTATIC FORCEPS CVD 24CM

Artikel-Nr.	Menge quantity cantidad	Beschreibung Description descripción
AI 333-20	1	PEAN (ROCHESTER) HEMOSTAT FCPS CVD 20CM
AI 380-16	10	ROCHESTER-CARMALT HEMOSTAT FCPS STR
AI 416-16	10	KOCHER HEMOSTATIC FORCEPS 1X2T STR 16CM
AI 475-19	6	MIXTER DISSECTING CLAMP CVD 19CM
AI 521-24	3	CRAFOORD DISS CLAMP CVD 24CM
AK 151-08	6	BACKHAUS TOWEL FORCEPS 8CM
AK 151-13	6	BACKHAUS TOWEL FORCEPS 13CM
AL 200-25	8	FOERSTER SPONGE HOLD FCPS SERR STR 25CM
AN 220-16	3	HEGAR-BAUMGARTNER NEEDLE HOLDER 16CM
AN 300-16	3	MAYO-HEGAR NEEDLE HOLDER 16CM
AN 300-18	5	MAYO-HEGAR NEEDLE HOLDER 18CM
AN 300-20	3	MAYO-HEGAR NEEDLE HOLDER 20CM
AS 100-03	6	SCALPEL HANDLE NO 3 STANDARD
AS 110-03	6	SCALPEL HANDLE NO 3L LONG
AT 121-10	1	FRAZIER SUCTION TUBE 3.3MM 19CM
AT 200-00	2	YANKAUER SUCTION TUBE COMPLETE 27CM
AT 200-00	2	YANKAUER SUCTION TUBE COMPLETE 27CM
AX 240-08	2	CUSHING RETRACTOR 8MM 20CM
AX 240-10	2	CUSHING RETRACTOR 10MM 20CM
AX 324-04	4	VOLKMANN RETRACTOR 4 PRONGS SHARP
AX 520-01	2	MIDDELDORPF RETRACTOR 16X14MM 21.5CM
AX 610-00	1	PARKER RETRACTOR SET #1-2 14CM
AX 630-00	1	PARKER-LANGENBECK RETRACT SET #1-2 21CM
AX 650-01	1	DAVIDSON SCAP RETR 75X50 16CM
AX 680-01	2	RICHARDSON RETRACTOR 25X20MM 24CM
AX 680-02	2	RICHARDSON RETRACTOR 30X27MM 24CM
AX 680-03	2	RICHARDSON RETRACTOR 38X38MM 24CM
AX 680-04	2	RICHARDSON RETRACTOR 50X20MM 24CM
AX 800-04	2	DEAVER RETRACTOR 25MM 30CM
AX 800-08	1	DEAVER RETRACTOR 50MM 30CM
AX 800-09	2	DEAVER RETRACTOR 75MM 30CM
AX 910-30	1	ABDOMINAL SPATULA MALLEABLE 30MM 33CM
AX 910-40	1	ABDOMINAL SPATULA MALLEABLE 40MM 33CM
AX 910-50	1	ABDOMINAL SPATULA MALLEABLE 50MM 33CM
AZ 124-13	2	WEITLANER RETRACTOR 3X4T SHARP 13CM
AZ 270-18	2	GELPI SELF-RETAINING RETRACTOR 18CM
LA 250-25	1	LEBSCHÉ STERNUM CHISEL 25CM
LA 620-01	1	FINOCHIETTO RIB SPREAD STAIN STEEL
LA 620-03	1	FINOCHIETTO RIB SPREAD STAIN STEEL
LA 760-18	1	BAILEY RIB CONTRACTOR 18CM
MC 120-15	6	ALLIS INTESTINAL FORCEPS 5X6T 15CM
MC 120-19	3	ALLIS INTESTINAL FORCEPS 5X6T 19CM
MC 150-15	4	ALLIS-ADAIR INTESTINAL FCPS 10X11T 15CM
MC 300-16	4	BABCOCK INTESTINAL TISSUE HOLD FCPS
OD 900-02	1	WILLIGER MALLETT W LEAD FILLING 340G
OD 330-15	1	FARABEUF PERIOST RASPATORY STR 13MM
OD 420-17	1	DOYEN RASPATORY F ADULTS BL L-CVD 17CM
OD 421-17	1	DOYEN RASPATORY F ADULTS BL R-CVD 17CM

Artikel-Nr.	Menge quantity cantidad	Beschreibung Description descripción
<b>ZT 126-00</b>		
<b>Instrumenten-Set für die Chirurgie der Zwerchfellhernie Diaphragmatic Hernia Repair Set Set de Reparación Hernia Diafragmática</b>		
AA 102-14	1	SURGICAL SCISSOR SH/BL STR 14.5CM
AA 170-17	1	MAYO DISSECTING SCISSOR STR 17CM
AA 170-23	1	MAYO DISSECTING SCISSOR STR 23CM
AA 171-17	1	MAYO DISSECTING SCISSOR CVD 17CM
AA 201-18	2	METZENBAUM DISS SCISSOR BL/BL CVD 18CM
AA 201-23	2	METZENBAUM DISS SCISSOR BL/BL CVD 23CM
AE 100-14	2	DRESSING FORCEPS STANDARD STR 14.5CM
AE 100-20	1	DRESSING FORCEPS STANDARD STR 20CM
AE 250-21	1	POTTS-SMITH DRESSING FCPS STR 21CM
AE 250-25	1	POTTS-SMITH DRESSING FCPS STR 25CM
AE 406-14	2	TISSUE FORCEPS 1X2T STR 14.5CM
AE 406-20	1	TISSUE FORCEPS 1X2T STR 20CM
AE 566-25	1	POTTS-SMITH TISSUE FORCEPS 1X2T STR
AI 100-12	10	HALSTEAD-MOSQUITO HEMOST FCPS STR
AI 101-12	10	HALSTEAD-MOSQUITO HEMOST FCPS CVD
AI 140-16	4	RANKIN-CRILE HEMOSTATIC FORCEPS STR
AI 141-16	4	RANKIN-CRILE HEMOSTATIC FORCEPS CVD
AI 333-16	8	PEAN (ROCHESTER) HEMOSTAT FCPS CVD 16CM
AI 416-16	4	KOCHER HEMOSTATIC FORCEPS 1X2T STR 16CM
AI 485-23	4	MIXTER DISSECTING CLAMP CVD 23CM
AK 151-13	10	BACKHAUS TOWEL FORCEPS 13CM
AL 200-25	4	FOERSTER SPONGE HOLD FCPS SERR STR 25CM
AN 220-16	1	HEGAR-BAUMGARTNER NEEDLE HOLDER 16CM
AN 300-16	1	MAYO-HEGAR NEEDLE HOLDER 16CM
AN 300-18	2	MAYO-HEGAR NEEDLE HOLDER 18CM
AN 300-24	1	MAYO-HEGAR NEEDLE HOLDER 24CM
AN 300-26	2	MAYO-HEGAR NEEDLE HOLDER 26CM
AN 500-20	1	DESCHAMPS LIGAT NEEDLE RIGHT CVD BL
AN 501-20	1	DESCHAMPS LIGAT NEEDLE LEFT CVD BL 20CM
AN 651-01	1	KOENIG LIGATURE CONDUCT 2.8MM CVD
AS 100-03	1	SCALPEL HANDLE NO 3 STANDARD
AS 100-04	1	SCALPEL HANDLE NO 4
AS 100-07	1	SCALPEL HANDLE NO 7
AS 105-07	1	SCALPEL HANDLE FIG 7K,WITH SOLID HANDLE
AT 200-00	1	YANKAUER SUCTION TUBE COMPLETE 27CM
AW 120-13	1	BUTTON-END PROBE W EYE DIA 2.0MM 13CM
AX 240-10	2	CUSHING RETRACTOR 10MM 20CM
AX 322-04	2	VOLKMANN RETRACTOR SEMISHARP
AX 322-06	2	VOLKMANN RETRACTOR SEMISHARP
AX 600-00	1	ROUX RETRACTOR SET #1-3 16.5CM
AX 630-00	1	PARKER-LANGENBECK RETRACT SET #1-2 21CM
AX 680-01	2	RICHARDSON RETRACTOR 25X20MM 24CM
AX 680-02	2	RICHARDSON RETRACTOR 30X27MM 24CM
AX 800-08	2	DEAVER RETRACTOR 50MM 30CM
AX 910-30	1	ABDOMINAL SPATULA MALLEABLE 30MM 33CM
AX 910-40	2	ABDOMINAL SPATULA MALLEABLE 40MM 33CM
AZ 480-00	1	BALFOUR ABDOMINAL RETRACTOR COMPLETE
MC 120-15	4	ALLIS INTESTINAL FORCEPS 5X6T 15CM
MC 300-16	2	BABCOCK INTESTINAL TISSUE HOLD FCPS
MC 300-24	2	BABCOCK INTESTINAL TISSUE HOLD FCPS

Artikel-Nr.	Menge quantity cantidad	Beschreibung Description descripción
LA 120-34	1	BETHUNE RIB SHEAR 34CM
LA 590-00	2	TUFFIER RIB SPREADER STAINL STEEL 165MM
LA 620-02	1	FINOCHIETTO RIB SPREAD STAIN STEEL
LA 760-16	1	BAILEY-BABY RIB CONTRACTOR 16CM
OD 330-15	1	FARABEUF PERIOST RASPATORY STR 13MM
OD 420-17	1	DOYEN RASPATORY F ADULTS BL L-CVD 17CM
OD 421-17	1	DOYEN RASPATORY F ADULTS BL R-CVD 17CM
OR 571-22	1	STILLE-LUER BONE RONGEUR CVD 8MM 22CM

### ZT 127-00

#### Instrumenten-Set für die periphere Vascularchirurgie Peripheral Vascular Set Set Vascular Periférico

AA 144-11	1	IRIS SCISSOR SH/SH STR 11.5CM
AA 145-11	1	IRIS SCISSOR SH/SH CVD 11.5CM
AA 331-14	1	METZENBAUM SCISSOR BL/BL CV 14,5CM
AA 611-17	1	TOENNIS-ADSON DISSECT SCISS CVD 17,5CM
AA 624-11	1	DISS SCISS STRAIGHT 11CM
AA 625-11	1	DISS SCISS CURVED 11CM
AA 651-15	1	REYNOLDS DISSECTING SCISSOR CVD 15CM
AE 120-16	2	DRESSING FORCEPS FINE STR 16CM
AE 230-15	2	MC INDOE DRESSING FORCEPS STR 15CM
AE 270-10	2	IRIS DRESSING FORCEPS STR 10CM
AE 426-18	2	TISSUE FORCEPS FINE 1X2T STR 18CM
AE 426-16	2	TISSUE FORCEPS FINE 1X2T STR 16CM
AE 476-15	2	GILLIES TISSUE FORCEPS 1X2T STR 15CM
AE 586-10	2	IRIS TISSUE FORCEPS 1X2T STR 10CM
AF 515-20	1	GRUENWALD NASAL DRESSING FORCEPS 20CM
AI 100-12	8	HALSTEAD-MOSQUITO HEMOST FCPS STR
AI 101-12	6	HALSTEAD-MOSQUITO HEMOST FCPS CVD
AK 151-08	8	BACKHAUS TOWEL FORCEPS 8CM
AL 200-25	2	FOERSTER SPONGE HOLD FCPS SERR STR 25CM
AN 300-18	1	MAYO-HEGAR NEEDLE HOLDER 18CM
AN 230-13	1	HALSEY NEEDLE HOLDER SERRATED JAW 13CM
AS 100-03	1	SCALPEL HANDLE NO 3 STANDARD
AX 240-14	2	CUSHING RETRACTOR 14MM 20CM
AZ 170-20	1	WEITLANER RETRACTOR 3X4T BLUNT 20CM
MC 180-15	2	JUDD-ALLIS TISSUE HOLDING FCPS 3X4T

Artikel-Nr.	Menge quantity cantidad	Beschreibung Description descripción
-------------	-------------------------------	--

### ZT 128-00

#### Instrumenten-Set für die Anlage des Arterio-venösen Shunt Arterio-Venous Shunt Set Set Shunt Arterio-Venoso

AB 217-45	1	DIETRICH VASCULAR SCISSOR 45DEG 18CM
AE 426-14	1	TISSUE FORCEPS FINE 1X2T STR 14.5CM
AI 101-12	4	HALSTEAD-MOSQUITO HEMOST FCPS CVD
AI 453-14	1	BABY-MIXTER DISSECT CLAMP STRONG
AK 151-08	4	BACKHAUS TOWEL FORCEPS 8CM
AL 200-18	2	FOERSTER SPONGE HOLD FCPS SERR STR 18CM
AN 244-15	2	CRILE-WOOD NEEDLE HOLDER 15CM
AO 221-14	1	MICRO-CASTR NDHLT GLATT O SPERR GEB
AS 100-03	1	SCALPEL HANDLE NO 3 STANDARD
AX 110-04	2	STANDARD HOOK 4 PRONGS BLUNT 16CM
AX 200-16	2	DESMARRES RETRACTOR 16MM 14CM
AZ 100-10	1	WEITLANER RETRACTOR 2X3T BLUNT 10.5CM
AZ 120-13	1	WEITLANER RETRACTOR 3X4T BLUNT 13CM
LH 301-05	2	BIEMER-MÜLLER APPROXIMATORS CVD
LH 311-05	2	BIEMER-MÜLLER APPROXIMATOR, CURVED

### ZT 129-00

#### Instrumenten-Set für die Herzkatheterisation Cardiac Catheterisation Set Set de Cateterización Cardíaca

AA 104-14	2	SURGICAL SCISSOR SH/SH STR 14.5CM
AA 201-14	1	METZENBAUM DISS SCISSOR BL/BL CVD
AA 201-18	2	METZENBAUM DISS SCISSOR BL/BL CVD 18CM
AB 237-45	1	POTTS-SMITH VASCULAR SCISS 45DEG 19CM
AE 160-12	2	ADSON DRESSING FORCEPS STR 12CM
AE 486-12	2	ADSON TISSUE FORCEPS 1X2T STR 12CM
AI 101-12	12	HALSTEAD-MOSQUITO HEMOST FCPS CVD
AI 131-14	12	CRILE HEMOSTATIC FORCEPS CVD 14CM
AI 451-18	2	BABY-MIXTER DISSECT CLAMP LIGHT CVD
AK 151-08	12	BACKHAUS TOWEL FORCEPS 8CM
AL 200-18	8	FOERSTER SPONGE HOLD FCPS SERR STR 18CM
AN 244-15	2	CRILE-WOOD NEEDLE HOLDER 15CM
AS 100-03	1	SCALPEL HANDLE NO 3 STANDARD
AX 014-01	2	GILLIES HOOK SMALL 18CM
AX 154-03	2	SENN-MILLER RETRACTOR SHARP 20X6MM 16CM
AZ 270-18	1	GELPI SELF-RETAINING RETRACTOR 18CM
HG 673-05	2	JOSEPH NASAL HOOKLET 2 PRONG 5MM SH
LK 170-18	2	DEBAKEY-PEAN ATRAUMAT HEM FCPS STR 18CM

Artikel-Nr.	Menge quantity cantidad	Beschreibung Description descripción
-------------	-------------------------------	--

Artikel-Nr.	Menge quantity cantidad	Beschreibung Description descripción
-------------	-------------------------------	--

## ZT 130-00

### Instrumenten-Set für Lungenlappen- und Lungensegmentresektion Lobectomy and Segmental Lung Resection Set Lobectomía y Resección Segmental del Pulmón

AA 201-28	1	METZENBAUM DISS SCISSOR BL/BL CVD 28CM
AE 250-25	1	POTTS-SMITH DRESSING FCPS STR 25CM
AE 566-25	1	POTTS-SMITH TISSUE FORCEPS 1X2T STR
AE 720-23	1	NELSON GRASPING FORCEPS 23CM
AI 241-24	4	CRAFOORD HEMOSTATIC FORCEPS CVD 24CM
AI 333-18	6	PEAN (ROCHESTER) HEMOSTAT FCPS CVD 18CM
AI 333-20	6	PEAN (ROCHESTER) HEMOSTAT FCPS CVD 20CM
AI 485-23	2	MIXTER DISSECTING CLAMP CVD 23CM
AI 521-24	4	CRAFOORD DISS CLAMP CVD 24CM
AI 615-28	4	MIXTER GALL DUCT CLAMP STRONG CURVE
AN 330-27	1	MASSON NEEDLE HOLDER
LA 220-27	1	GIERTZ-STILLE RIB SHEAR 27CM
LA 250-25	1	LEBSCHER STERNUM CHISEL 25CM
LA 620-02	1	FINOCHIETTO RIB SPREAD STAIN STEEL
LA 750-20	1	SELLORS RIB CONTRACTOR 20CM
LA 800-30	1	ALLISON LUNG SPATULA 30CM
LM 201-22	1	PRICE-THOMAS BRONCHUS CLAMP 22CM
LM 205-22	1	PRICE-THOMAS BRONCHUS CLAMP LEFT 22CM
LM 207-22	1	PRICE-THOMAS BRONCHUS CLAMP RIGHT 22CM
LM 251-24	1	SEMB LIGATURE CLAMPS SLIGHT CURVED 24CM
MC 120-19	6	ALLIS INTESTINAL FORCEPS 5X6T 19CM
MC 410-20	6	COLLIN-DUVAL INTESTINAL FCPS 15MM 20CM
MC 412-23	2	COLLIN-DUVAL INTESTINAL FCPS 25MM 23CM
OD 420-17	1	DOYEN RASPATORY F ADULTS BL L-CVD 17CM
OD 421-17	1	DOYEN RASPATORY F ADULTS BL R-CVD 17CM
OD 431-05	1	LAMBOTTE RASPATORY CURVED 5MM 21CM
OD 900-02	1	WILLIGER MALLETT W LEAD FILLING 340G
OR 571-22	1	STILLE-LUER BONE RONGEUR CVD 8MM 22CM

