

SEKTION G
OBSTETRIK - GYNÄKOLOGIE



SECTION G
OBSTETRICS - GYNECOLOGY

SECCIÓN G
OBSTETRICIA - GINECOLOGÍA

Inhaltsverzeichnis	Contents	Contenido		Seite, Page, Página
Sektion G	Section G	Sección G		
Beckenzirkel, Geburtszangen	Pelvimeter, Obstetrical Forceps	Pelvímetro, Forceps obstétricos	GA	G.01 - G.05
Geburtslöffel, Nabelschnurklemme, Kranioklast	Obstetrical Lever, Umbilical Cord Clamps, Cranioclast	Elevator obstétrico, Clamps umbilicales, Craneoclasto	GA	G.06
Vaginalspekula, Endspekula	Vaginal Specula, Endo-Cervical Specula	Espéculos vaginales, Endospéculos	GD	G.07 - G.20
Uterusdilatoren	Uterine Dilators	Dilatadores uterinos	GK	G.21 - G.23
Uterussonden, Uterusdepressor	Uterine Probes and Depressors	Histerómetros, Depresors uterino	GK	G.24
Saug- und Biopsieküretten	Suction and Biopsy Curettes	Curetas de aspiración y biopsia	GK	G.25
Uterusküretten, Uteruslöffel	Uterine Curettes, Uterine Scoops	Curetas uterinas, Cucharillas uterinas	GK	G.26 - G.28
Abortus- und Absaugküretten	Placenta and Aspirating curettes	Curetas placentas y uterinas de aspiración	GK	G.29
Hysterosalpingograph	Hysterolsalpingograph	Histerosalpingógrafo	GK	G.30
Hakenzangen	Enaculum Forceps	Pinzas para cuello uterino	GK	G.31 - 34
Ovarienzangen, Uterusfasszangen, Uteruspolypenzangen	Ovary Forceps, Uterine Grasping Forceps, Uterine Forceps	Pinzas para pólipos uterinos, Pinzas para cuello uterino, Pinzas para pólipos uterinos	GK	G.35
Plazentazangen, Abortuszangen, Uteruszangen	Placenta Forceps, Abortion Forceps, Uterine Forceps	Pinzas para placenta, Pinzas para útero, Pinzas para aborto	GK	G.36 - G.37
Myom-Instrumente, Fistelhaken	Myom-Instruments, Fistula Hooks	Instrumentos para fibroma, Ganchos para fistulas	GK	G.38
Biopsiezangen	Biopsy Forceps	Pinzas para biopsia	GO	G.39 - G.43
Setvorschläge	Set Suggestions	Proposición de Sets	ZG	G.44 - G.49

**Beckenzirkel, Geburtszangen
Pelvimeter, Obstetrical Forceps
Pelvímetro, forceps obstétricos**



Martin

Beckenzirkel mit cm / Zolleinteilung

Pelvimeter with cm / inch scale

Pelvímetro con escala cm / pulgada

GA 100-34 34 cm / 13½"



Simpson

GA 230-30 30 cm / 12"



Simpson-Braun

GA 260-36 36 cm / 14"



Simpson-Luikart

GA 290-36 36 cm / 14"

Geburtszangen
Obstetrical Forceps
Forceps obstétricos



Wrigley
GA 310-28 28 cm / 11"



Kielland
GA 320-41 41 cm / 16"



Kielland-Luikart
GA 350-40 40 cm / 15¾"



DeLee
GA 380-30 30 cm / 12"



De Lee
GA 380-36 36 cm / 14"

Geburtszangen
Obstetrical Forceps
Forceps obstétricos



Elliot
GA 410-38 38 cm / 15"



McLean - Luikart
GA 430-39 39 cm / 15½"



McLean-Tucker-Luikart
GA 440-40 40 cm / 15¾"

Geburtszangen
Obstetrical Forceps
Forceps obstétricos



McLean-Tucker
GA 445-39 39 cm / 15½"



Piper
GA 450-44 44 cm / 17¼"



Luikart
GA 460-40 40 cm / 15¾"



Dewey
mit Zughebel
with traction handle
con tractor
GA 470-37 37 cm / 14½"

Geburtszangen
Obstetrical Forceps
Forceps obstétricos



Murless

Kopfhebel

Head extractor

Elevador de cabeza

GA 480-26 26 cm / 10¼"



Bill

Zughebel für alle Geburtszangen mit
gehorntem Standardgriff

Traction handle for any obstetrical forceps with
horned standard handle

Mango de tracción para todos los forceps
obstétricos con mango standard cornudo

GA 490-20 20 cm / 8"



Braun

Dekapitationshaken

Decapitation hook

Gancho para decapitación

GA 495-30 30 cm / 12"

Geburtslöffel, Nabelschnurklemme, Kranioklast
Obstetrical Lever, Umbilical Cord Clamp, Cranioclast
Elevador obstétrico, Clamps umbilicales, Craneoclasto



Sellheim
Geburtslöffel
Obstetrical Lever
Elevador obstétrico
GA 510-28 28 cm / 12½"



Kane
Nabelschnurklemme
Umbilical Cord Clamp
Clamp umbilicales
GA 520-09 8,5 cm / 3¼"



Braun
Kranioklast
Cranioclast
Craneoclasto
GA 540-42 42 cm / 16½"

Vaginalspekula
Vaginal Specula
Espéculos vaginales

Maße der Blätter: Tiefe x Breite

Dimensions of blades: Depth x Width

Dimensiones de las hojas: Profundidad x Anchura



Collin

für Kinder – for children – para niños

GD 100-01 65 mm x 10 mm

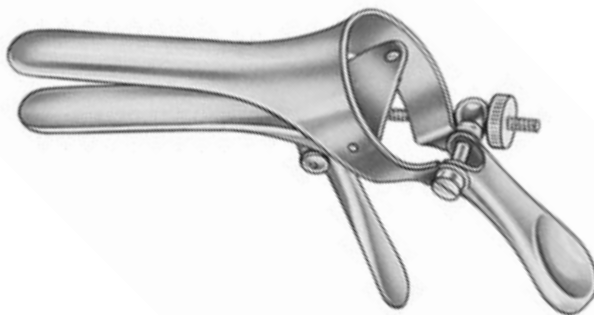

Cusco

für Jungfrauen – for virgins – para vírgenes

mit umklappbaren Griffen

with foldable handles

con mangos plegables

GD 120-01 75 mm x 17 mm



Cusco

mit umklappbaren Griffen

with foldable handles

con mangos plegables

GD 140-01 75 mm x 32 mm

GD 140-02 85 mm x 35 mm

GD 140-03 100 mm x 35 mm

Vaginalspekula
Vaginal Specula
Espéculos vaginales

Maße der Blätter: Tiefe x Breite

Dimensions of blades: Depth x Width

Dimensiones de las hojas: Profundidad x Anchura



Cusco

"Entenschnabel"-Modell

"Duck's bill"-pattern

Modelo "pico de pato"

GD 160-01 75 mm x 32 mm

GD 160-02 85 mm x 35 mm

GD 160-03 100 mm x 37 mm



Cusco

Schweizer Modell

Swiss pattern

Modelo suizo

GD 180-01 80 mm x 22 mm

GD 180-02 100 mm x 25 mm

GD 180-03 105 mm x 27 mm



Pederson

GD 200-01 75 mm x 13 mm

GD 200-02 100 mm x 22 mm

GD 200-03 120 mm x 25 mm

Vaginalspekula
Vaginal Specula
Espéculos vaginales

Maße der Blätter: Tiefe x Breite

Dimensions of blades: Depth x Width

Dimensiones de las hojas: Profundidad x Anchura



Graves

GD 220-01 75 mm x 20 mm

GD 220-02 95 mm x 35 mm

GD 220-03 115 mm x 35 mm



Semm

GD 250-01 100 mm x 17 mm / 20 mm

GD 250-02 100 mm x 25 mm / 30 mm



Seyffert

GD 260-01 100 mm x 17 mm

GD 260-02 110 mm x 33 mm

Vaginalspekula
Vaginal Specula
Espéculos vaginales

Maße der Blätter: Tiefe x Breite

Dimensions of blades: Depth x Width

Dimensiones de las hojas: Profundidad x Anchura



Collin

GD 270-01	85 mm x 30 mm
GD 270-02	100 mm x 35 mm
GD 270-03	110 mm x 40 mm



Trélat

GD 290-01	85 mm x 33 mm
GD 290-02	95 mm x 35 mm
GD 290-03	115 mm x 43 mm

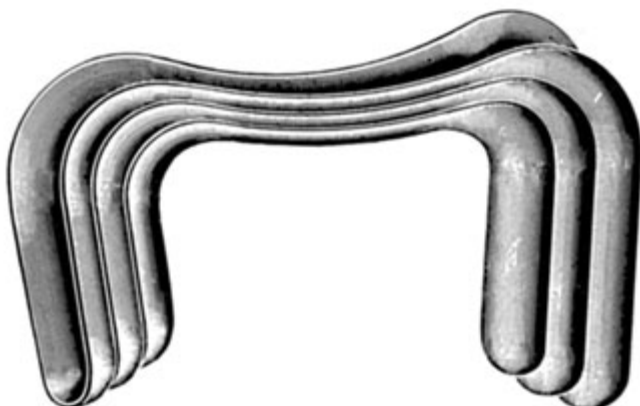

Sims

GD 401-01	65 x 25 mm / 70 x 30 mm
GD 401-02	70 x 30 mm / 70 x 35 mm
GD 401-03	85 x 35 mm / 90 x 40 mm

Vaginalspekula
Vaginal Specula
Espéculos vaginales

Maße der Blätter: Tiefe x Breite

Dimensions of blades: Depth x Width

Dimensiones de las hojas: Profundidad x Anchura



Seidl

für Kinder
for children
para niños

GD 410-01 80 mm x 8 mm

GD 410-02 80 mm x 10 mm

GD 410-03 90 mm x 14 mm

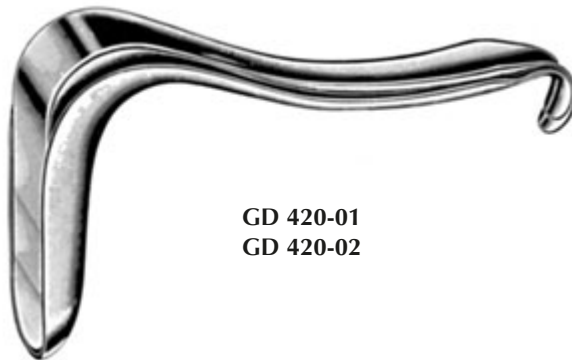

GD 420-01

GD 420-02

Kristeller

Standardmodelle
Standard patterns
Modelos standard

Satz - set - juego

GD 420-01

bestehend aus - consisting of - compuesto de:

Spekulum - specula - espéculo

GD 421-01 70 mm x 27 mm

Halter - retractor - valva

GD 422-01 75 mm x 23 mm

Satz - set - juego

GD 420-02

bestehend aus - consisting of - compuesto de:

Spekulum - specula - espéculo

GD 421-02 80 mm x 30 mm

Halter - retractor - valva

GD 422-02 85 mm x 26 mm

Vaginalspekula
Vaginal Specula
Espéculos vaginales

Maße der Blätter: Tiefe x Breite

Dimensions of blades: Depth x Width

Dimensiones de las hojas: Profundidad x Anchura



Kristeller
Standardmodell
Standard pattern
Modelo standard

Satz - set - juego
GD 420-03

bestehend aus - consisting of - compuesto de:

Spekulum - specula - espéculo
GD 421-03 90 mm x 36 mm

Halter - retractor - valva
GD 422-03 100 mm x 32 mm

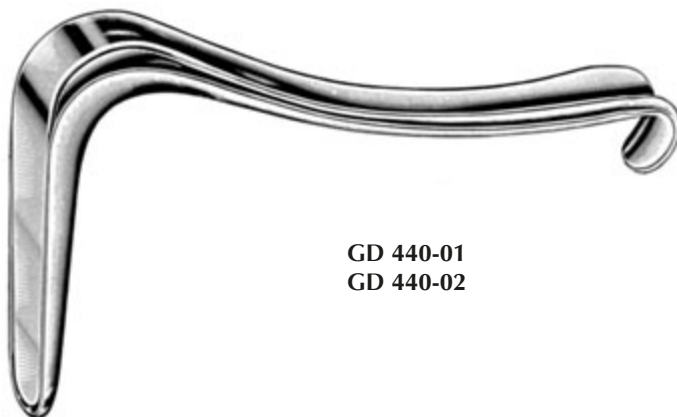

GD 440-01
GD 440-02

Kristeller
extra schmale Modelle
extra narrow patterns
modelos extra estrechos

Satz - set - juego
GD 440-01

bestehend aus - consisting of - compuesto de:

Spekulum - specula - espéculo
GD 441-01 105 mm x 18 mm

Halter - retractor - valva
GD 442-01 110 mm x 14 mm

Satz - set - juego
GD 440-02

bestehend aus - consisting of - compuesto de:

Spekulum - specula - espéculo
GD 441-02 105 mm x 21 mm

Halter - retractor - valva
GD 442-02 110 mm x 17 mm

Vaginalspekula
Vaginal Specula
Espéculos vaginales

Maße der Blätter: Tiefe x Breite

Dimensions of blades: Depth x Width

Dimensiones de las hojas: Profundidad x Anchura



Kristeller

für Kinder - for children - para niños

Satz – set – juego

GD 450-01

bestehend aus - consisting of - compuesto de:

Spekulum - specula - espéculo

GD 451-01 70 mm x 15 mm

Halter - retractor - valva

GD 452-01 70 mm x 11 mm

Vaginalspekula
Vaginal Specula
Espéculos vaginales

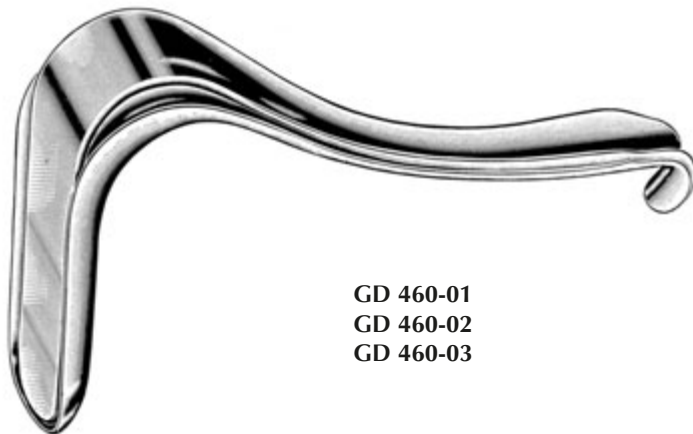

GD 460-01
GD 460-02
GD 460-03

Maße der Blätter: Tiefe x Breite

Dimensions of blades: Depth x Width

Dimensiones de las hojas: Profundidad x Anchura

Kristeller

lange tiefe Modelle
long and deep patterns
modelos largos y anchos

Satz - set - juego

GD 460-01

bestehend aus - consisting of - compuesto de:

Spekulum - specula - espéculo

GD 461-01 110 mm x 27 mm

Halter - retractor - valva

GD 462-01 115 mm x 23 mm

Satz - set - juego

GD 460-02

bestehend aus - consisting of - compuesto de:

Spekulum - specula - espéculo

GD 461-02 110 mm x 30 mm

Halter - retractor - valva

GD 462-02 115 mm x 26 mm

Satz - set - juego

GD 460-03

bestehend aus - consisting of - compuesto de:

Spekulum - specula - espéculo

GD 461-03 110 mm x 36 mm

Halter - retractor - valva

GD 462-03 115 mm x 32 mm

Vaginalspekula
Vaginal Specula
Espéculos vaginales



GD 480-01
GD 480-02
GD 480-03

Maße der Blätter: Tiefe x Breite

Dimensions of blades: Depth x Width

Dimensiones de las hojas: Profundidad x Anchura

Kristeller

lange flache Modelle
long and shallow patterns
modelos largos y planos

Satz - set - juego

GD 480-01

bestehend aus - consisting of - compuesto de:

Spekulum - specula - espéculo

GD 481-01 105 mm x 26 mm

Halter - retractor - valva

GD 482-01 115 mm x 22 mm

Satz - set - juego

GD 480-02

bestehend aus - consisting of - compuesto de:

Spekulum - specula - espéculo

GD 481-02 105 mm x 28 mm

Halter - retractor - valva

GD 482-02 115 mm x 24 mm

Satz - set - juego

GD 480-03

bestehend aus - consisting of - compuesto de:

Spekulum - specula - espéculo

GD 481-03 105 mm x 33 mm

Halter - retractor - valva

GD 482-03 115 mm x 29 mm

Vaginalspekula
Vaginal Specula
Espéculos vaginales

Maße der Blätter: Tiefe x Breite

Dimensions of blades: Depth x Width

Dimensiones de las hojas: Profundidad x Anchura



Eastman

GD 492-75 75 mm x 35 mm

GD 492-90 90 mm x 35 mm

GD 492-99 100 mm x 35 mm

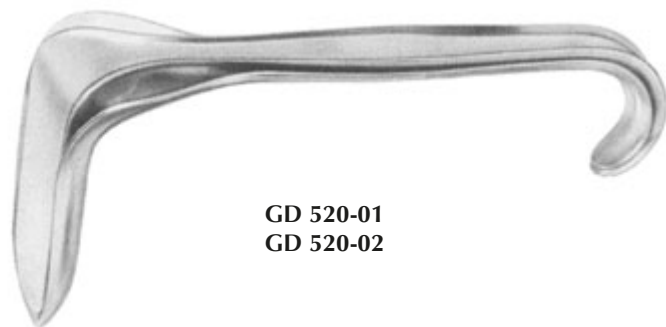

GD 520-01
GD 520-02

Kallmorgen

Satz - set - juego

GD 520-01 70 mm x 40 mm

bestehend aus - consisting of - compuesto de:

Spekulum - specula - espéculo

GD 521-01 70 mm x 40 mm

Halter - retractor - valva

GD 522-01 75 mm x 33 mm

Satz - set - juego

GD 520-02 90 mm x 40 mm

bestehend aus - consisting of - compuesto de:

Spekulum - specula - espéculo

GD 521-02 90 mm x 40 mm

Halter - retractor - valva

GD 522-02 95 mm x 33 mm

Vaginalspekula
Vaginal Specula
Espéculos vaginales

Maße der Blätter: Tiefe x Breite

Dimensions of blades: Depth x Width

Dimensiones de las hojas: Profundidad x Anchura



Doyen

flaches Blatt - flat blade - hoja plana

24 cm / 9½"

GD 540-24 70 mm x 30 mm

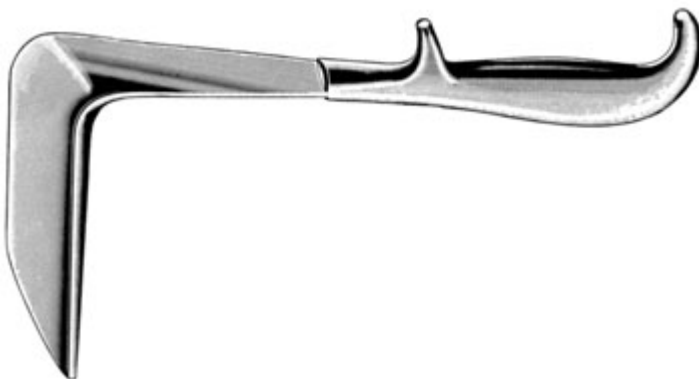

Doyen

leicht hohl - slightly concave - ligeramente cóncavas

24 cm / 9½"

GD 550-01 55 mm x 35 mm
GD 550-02 85 mm x 35 mm
GD 550-03 115 mm x 35 mm

GD 560-01 55 mm x 45 mm
GD 560-02 85 mm x 45 mm
GD 560-03 115 mm x 45 mm
GD 560-04 160 mm x 45 mm

GD 570-01 55 mm x 60 mm
GD 570-02 85 mm x 60 mm
GD 570-03 115 mm x 60 mm
GD 570-04 160 mm x 60 mm



Breisky

29 cm / 11½"

GD 600-20 100 mm x 20 mm
GD 600-25 100 mm x 25 mm
GD 600-30 100 mm x 30 mm
GD 600-35 100 mm x 35 mm
GD 600-40 100 mm x 40 mm

32 cm / 12½"

GD 610-20 130 mm x 20 mm
GD 610-25 130 mm x 25 mm
GD 610-30 130 mm x 30 mm
GD 610-35 130 mm x 35 mm
GD 610-40 130 mm x 40 mm

32 cm / 12½"

GD 620-40 160 mm x 40 mm

Vaginalspekula
Vaginal Specula
Espéculos vaginales

Maße der Blätter: Tiefe x Breite

Dimensions of blades: Depth x Width

Dimensiones de las hojas: Profundidad x Anchura

Scherbak

Satz – set – juego

GD 650-00

bestehend aus – consisting of – compuesto de

Griff – handle – mango

GD 651-01

Gewicht – weight - peso

GD 652-01 400 g

Blatt – Specula Blade – Valva vaginal

GD 653-01 80 mm x 30 mm

GD 653-02 85 mm x 35 mm

GD 653-03 90 mm x 40 mm

GD 653-04 55 mm x 40 mm – 60 mm

GD 653-05 70 mm x 45 mm – 70 mm



GD 653-01



GD 653-02



GD 653-03



GD 653-04



GD 653-05

Vaginalspekula
Vaginal Specula
Espéculos vaginales



Auvar

komplett, mit abnehmbarem Gewicht

complete, with removable weight

completo, con peso desmontable

GD 670-00 80 mm x 38 mm

Gewicht - weight - peso

GD 671-01 1,14 kg

Vaginalspekulum, Endospekula
Vaginal Specula, Endo-Cervical Specula
Espéculo vaginal, endospéculos



Maße der Blätter: Tiefe x Breite

Dimensions of blades: Depth x Width

Dimensiones de las hojas: Profundidad x Anchura

O'Sullivan-O'Connor
komplett - complete - completo
GD 700-00

bestehend aus - consisting of - compuesto de:

Rahmen allein - frame only - cuadro solo
GD 701-01

Valve - blade - valva
GD 702-17 45 mm x 17 mm
GD 702-37 90 mm x 37 mm
GD 702-45 90 mm x 45 mm



Kogan
mit Skala - with scale - con escala
GD 750-24 24 cm / 9½"



Kogan
GD 751-24 24 cm / 9½"

Uterusdilatoren Uterine Dilators Dilatadores uterinos



Hegar

einendig - single-ended - un extremo

GK 100-01 ø 1 mm	GK 100-14 ø 14 mm
GK 100-02 ø 2 mm	GK 100-15 ø 15 mm
GK 100-03 ø 3 mm	GK 100-16 ø 16 mm
GK 100-04 ø 4 mm	GK 100-17 ø 17 mm
GK 100-05 ø 5 mm	GK 100-18 ø 18 mm
GK 100-06 ø 6 mm	GK 100-19 ø 19 mm
GK 100-07 ø 7 mm	GK 100-20 ø 20 mm
GK 100-08 ø 8 mm	GK 100-21 ø 21 mm
GK 100-09 ø 9 mm	GK 100-22 ø 22 mm
GK 100-10 ø 10 mm	GK 100-23 ø 23 mm
GK 100-11 ø 11 mm	GK 100-24 ø 24 mm
GK 100-12 ø 12 mm	GK 100-25 ø 25 mm
GK 100-13 ø 13 mm	GK 100-26 ø 26 mm



Hegar

einendig - single-ended - un extremo

GK 101-01 ø 1,5 mm	GK 101-10 ø 10,5 mm
GK 101-02 ø 2,5 mm	GK 101-11 ø 11,5 mm
GK 101-03 ø 3,5 mm	GK 101-12 ø 12,5 mm
GK 101-04 ø 4,5 mm	GK 101-13 ø 13,5 mm
GK 101-05 ø 5,5 mm	GK 101-14 ø 14,5 mm
GK 101-06 ø 6,5 mm	GK 101-15 ø 15,5 mm
GK 101-07 ø 7,5 mm	GK 101-16 ø 16,5 mm
GK 101-08 ø 8,5 mm	GK 101-17 ø 17,5 mm
GK 101-09 ø 9,5 mm	



Hegar

Satz zu 14 Dilatoren, *in Metalletui*

Set of 14 dilators, *in metal box*

Juego de 14 dilatadores, *en estuche de metal*

ø 4 mm - ø 17 mm (GK 100-04 - GK 100-17)

GK 120-00

Satz zu 14 Dilatoren, *ohne Etui*

Set of 14 dilators, *without box*

Juego de 14 dilatadores, *sin estuche*

ø 4 mm - ø 17 mm (GK 100-04 - GK 100-17)

GK 125-00

Satz zu 26 Dilatoren, *in Metalletui*

Set of 26 dilators, *in metal box*

Juego de 26 dilatadores, *en estuche de metal*

ø 1 mm - ø 26 mm (GK 100-01 - GK 100-26)

GK 130-00

Uterusdilatoren

Uterine Dilators

Dilatadores uterinos



Hegar

doppelendig - double-ended - dos extremos

GK 151-02	∅ 1,0 mm / 2,0 mm
GK 151-04	∅ 3,0 mm / 4,0 mm
GK 151-06	∅ 5,0 mm / 6,0 mm
GK 151-08	∅ 7,0 mm / 8,0 mm
GK 151-10	∅ 9,0 mm / 10,0 mm
GK 151-12	∅ 11,0 mm / 12,0 mm
GK 151-14	∅ 13,0 mm / 14,0 mm
GK 151-16	∅ 15,0 mm / 16,0 mm
GK 151-18	∅ 17,0 mm / 18,0 mm
GK 151-20	∅ 19,0 mm / 20,0 mm
GK 151-22	∅ 21,0 mm / 22,0 mm
GK 151-24	∅ 23,0 mm / 24,0 mm
GK 151-26	∅ 25,0 mm / 26,0 mm



GK 163-00

Hegar

doppelendig - double-ended - dos extremos

Satz zu 8 Dilatoren, in Metalletui

Set of 8 dilators, in metal box

Juego de 8 dilatadores, en estuche de metal

∅ 3 / 4 mm - ∅ 17 / 18 mm

(GK 151-04 - GK 151-18)

GK 160-00

Satz zu 8 Dilatoren, in Segeltuchtasche

Set of 8 dilators, in canvas pouch

Juego de 8 dilatadores, en bolsa de tela

∅ 3 / 4 mm - ∅ 17 / 18 mm

(GK 151-04 - GK 151-18)

GK 163-00

Satz zu 8 Dilatoren, ohne Etui

Set of 8 dilators, without case

Juego de 8 dilatadores, sin estuche

∅ 3 / 4 mm - ∅ 17 / 18 mm

(GK 151-04 - GK 151-18)

GK 165-00

Satz zu 13 Dilatoren, in Metalletui

Set of 13 dilators, in metal case

Juego de 13 dilatadores, en estuche de metal

∅ 1 / 2 mm - ∅ 25 / 26 mm

(GK 151-02 - GK 151-26)

GK 170-00

Satz zu 13 Dilatoren, ohne Etui

Set of 13 dilators, without case

Juego de 13 dilatadores, sin estuche

∅ 1 / 2 mm - ∅ 25 / 26 mm

(GK 151-02 - GK 151-26)

GK 175-00

Uterusdilatoren
Uterine Dilators
Dilatadores uterinos



Goodell
GK 180-34 34 cm / 13½"



Hank
doppelendig - double-ended - dos extremos
GK 201-05 Ø 4,5 mm / 5,0 mm
GK 201-06 Ø 5,0 mm / 6,0 mm
GK 201-07 Ø 6,5 mm / 7,0 mm
GK 201-08 Ø 7,5 mm / 8,0 mm
GK 201-09 Ø 8,5 mm / 9,0 mm
GK 201-10 Ø 9,5 mm / 10,0 mm

Satz zu 6 Dilatoren, *ohne Etui*
Set of 6 dilators, *without case*
Juego de 6 dilatadores, *sin estuche*

Ø 4,5 / 5,0 mm - Ø 9,5 / 10,0 mm
(GK 201-05 – GK 201-10)
GK 210-00

Satz zu 6 Dilatoren, in Segeltuchtasche
Set of 6 dilators, in canvas pouch
Juego de 6 dilatadores, en bolsa de tela

Ø 4,5 / 5,0 mm - Ø 9,5 / 10,0 mm
(GK 201-05 – GK 201-10)
GK 215-00

Uterussonden, Uterusdepressor
Uterine Probes and Depressor
Histerómetros, depresor uterino



Sims

rostfrei - stainless steel - acero inoxidable

GK 250-32 32 cm / 12½"

biegsam - malleable - maleable

GK 251-32 32 cm / 12½"



Valleix

GK 310-25 25 cm / 10"



Braun

GK 320-28 28 cm / 11"

Saug- und Biopsieküretten
Suction and Biopsy Curettes
Curetas de aspiración y biopsia

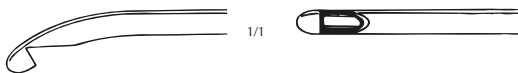

Randall

ø 4 mm

GK 340-25 25 cm / 10"

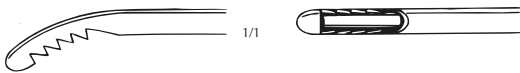

Novak

ø 1 mm

GK 370-01 25 cm / 10"

ø 2 mm

GK 370-02 25 cm / 10"

ø 3 mm

GK 370-03 25 cm / 10"

ø 4 mm

GK 370-04 25 cm / 10"



Kevorkian

ohne Korb - without basket - sin canasto

starr - rigid - rigida

GK 380-30 30,5 cm / 12"



Kevorkian

mit Korb - with basket - con canasto

starr - rigid - rigida

GK 382-30 30,5 cm / 12"



Muenchen

Breite - width - anchura 4,8mm

GK 391-27 27 cm / 10³/₄"

Uterusküretten
Uterine Curettes
Curetas uterinas



Recamier

31cm / 12¼"

stumpf - blunt - roma

starr - rigid - rigida

GK 400-05 # 00 5 mm	GK 400-16 # 8 16 mm
GK 400-06 # 0 6 mm	GK 400-19 # 9 19 mm
GK 400-07 # 1 7 mm	GK 400-20 # 10 20 mm
GK 400-08 # 2 8 mm	GK 400-21 # 11 21 mm
GK 400-09 # 3 9 mm	GK 400-23 # 12 23 mm
GK 400-11 # 4 11 mm	GK 400-25 # 13 25 mm
GK 400-12 # 5 12 mm	GK 400-30 # 14 30 mm
GK 400-14 # 6 14 mm	GK 400-35 # 15 35 mm
GK 400-15 # 7 15 mm	GK 400-40 # 16 40 mm

stumpf - blunt - roma

biegsam - malleable - maleable

GK 404-05 # 00 5 mm	GK 404-16 # 8 16 mm
GK 404-06 # 0 6 mm	GK 404-19 # 9 19 mm
GK 404-07 # 1 7 mm	GK 404-20 # 10 20 mm
GK 404-08 # 2 8 mm	GK 404-21 # 11 21 mm
GK 404-09 # 3 9 mm	GK 404-23 # 12 23 mm
GK 404-11 # 4 11 mm	GK 404-25 # 13 25 mm
GK 404-12 # 5 12 mm	GK 404-30 # 14 30 mm
GK 404-14 # 6 14 mm	GK 404-35 # 15 35 mm
GK 404-15 # 7 15 mm	GK 404-40 # 16 40 mm

scharf - sharp - cortante

starr - rigid - rigida

GK 405-05 # 00 5 mm	GK 405-16 # 8 16 mm
GK 405-06 # 0 6 mm	GK 405-19 # 9 19 mm
GK 405-07 # 1 7 mm	GK 405-20 # 10 20 mm
GK 405-08 # 2 8 mm	GK 405-21 # 11 21 mm
GK 405-09 # 3 9 mm	GK 405-23 # 12 23 mm
GK 405-11 # 4 11 mm	GK 405-25 # 13 25 mm
GK 405-12 # 5 12 mm	GK 405-30 # 14 30 mm
GK 405-14 # 6 14 mm	GK 405-35 # 15 35 mm
GK 405-15 # 7 15 mm	GK 405-40 # 16 40 mm

scharf - sharp - cortante

biegsam - malleable - maleable

GK 406-05 # 00 5 mm	GK 406-16 # 8 16 mm
GK 406-06 # 0 6 mm	GK 406-19 # 9 19 mm
GK 406-07 # 1 7 mm	GK 406-20 # 10 20 mm
GK 406-08 # 2 8 mm	GK 406-21 # 11 21 mm
GK 406-09 # 3 9 mm	GK 406-23 # 12 23 mm
GK 406-11 # 4 11 mm	GK 406-25 # 13 25 mm
GK 406-12 # 5 12 mm	GK 406-30 # 14 30 mm
GK 406-14 # 6 14 mm	GK 406-35 # 15 35 mm
GK 406-15 # 7 15 mm	GK 406-40 # 16 40 mm

Uterusküretten
Uterine Curettes
Curetas uterinas



Bumm

stumpf – blunt – roma

biegsam – malleable – malleable

GK 414-06	# 0	16 mm
GK 414-07	# 1	18 mm
GK 414-08	# 2	19,5 mm
GK 414-09	# 3	21,5 mm
GK 414-11	# 4	23,5 mm
GK 414-12	# 5	26 mm
GK 414-14	# 6	28,5 mm

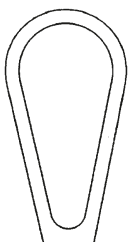

0

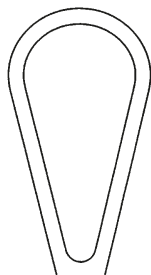

1

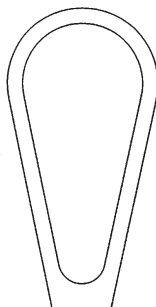

2

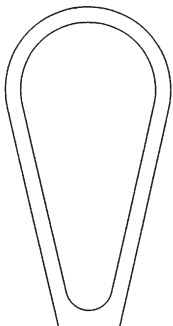

3

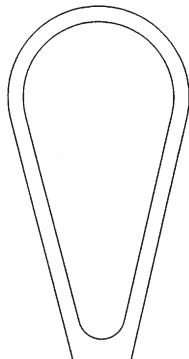

4

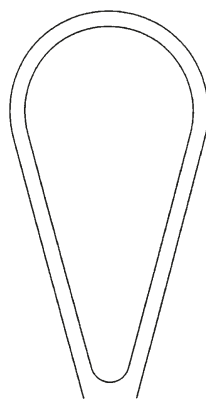

5

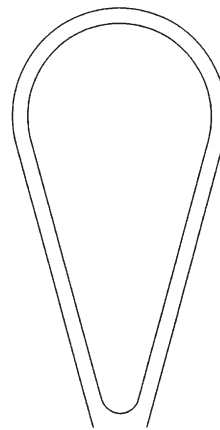

6



Blake

doppelendig – double-ended – dos extremos

stumpf-scharf – blunt-sharp – roma-cortante

GK 430-27 27,5 cm / 10¾"

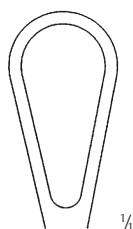

stumpf
blunt
roma



scharf
sharp
cortante

Uteruslöffel
Uterine Scoops
Cucharillas uterinas



Simon
 scharf - sharp - cortantes
 starr - rigid - rigida

25 cm / 10"

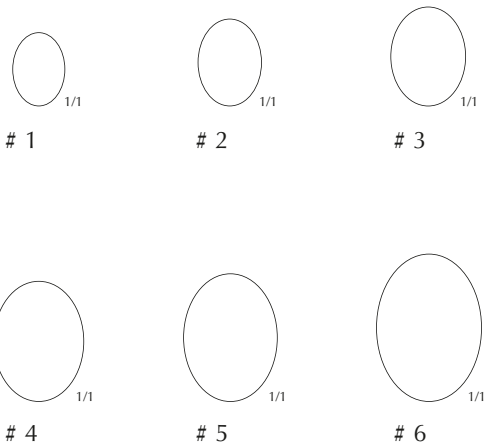

- GK 450-01** # 1
- GK 450-02** # 2
- GK 450-03** # 3
- GK 450-04** # 4
- GK 450-05** # 5
- GK 450-06** # 6



Schroeder
 scharf - sharp - cortantes
 starr - rigid - rigida

30 cm / 12"

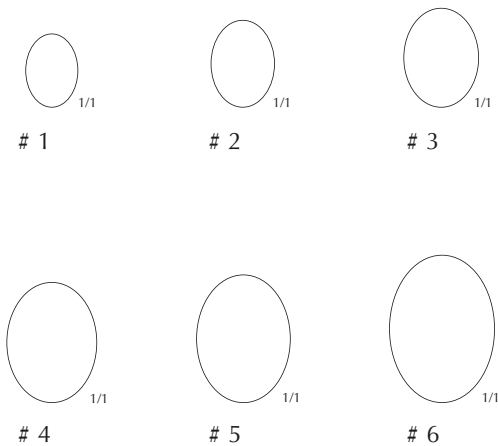

- GK 460-01** # 1
- GK 460-02** # 2
- GK 460-03** # 3
- GK 460-04** # 4
- GK 460-05** # 5
- GK 460-06** # 6

Abortus- und Absaugküretten
Placenta and Aspirating curettes
Curetas placentas y uterinas de aspiración



Wallich
GK 490-42 42 cm / 16³/₄"

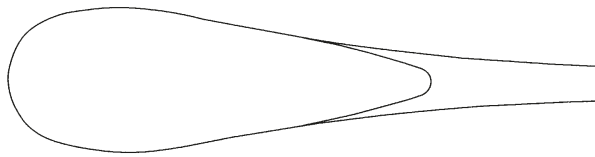

Probe- und Absaugkürette
Specimen and aspirating curette
Cureta para biopsía y aspiración



ø 4 mm
GK 550-04 28 cm / 11"



Absaugküretten
Aspirating curettes
Curetas para aspiración



ø 6 mm
GK 550-06 28 cm / 11"



ø 8 mm
GK 550-08 28 cm / 11"



ø 10 mm
GK 550-10 28 cm / 11"



ø 12 mm
GK 550-12 28 cm / 11"



ø 14 mm
GK 550-14 28 cm / 11"



Kupplungsstück
Connection piece
Pieza de conexión
GK 551-01 10 cm / 4"

Hysterosalpingograph
Hysterosalpingograph
Histerosalpingógrafa



bestehend aus:

- Hauptstück mit einzelverstellbaren Zangenhaltern
- Verbindungsstück
- Manometer mit Leuchtskala
- Luer-Lock Spritze 10 ccm
- 3 auswechselbare Uterusverschlußkegel in 3 verschiedenen Größen
- Holzetui

including:

- Main piece with adjustable forceps holders
- Connecting piece
- Manometer with luminous scale
- Luer-Lock syringe 10 ccm
- 3 exchangeable occluding nozzles in 3 different sizes
- wooden case

compuesto de:

- Pieza principal con porta-pinzas ajustables
- Pieza de conexión
- Manómetro con escala luminosa
- Jeringa Luer-Lock 10 ccm
- 3 conos uterinos intercambiables de 3 diferentes tamaños
- Estuche de madera

komplett - complete - completo

GK 590-00

Manometer mit Leuchtskala, allein

Manometer with luminous scale, only

Manómetro con escala luminosa, solo

GK 591-01

Salpingograph komplett, *ohne Manometer*

Salpingograph complete, *without manometer*

Salpingógrafa completo, *sin manómetro*

GK 595-00

Hakenzangen
Tenaculum Forceps
Pinzas para cuello uterino



Staude-Moore
GK 600-17 17 cm / 6¾"



Tiemann
GK 602-22 22 cm / 8¾"



Barrett
GK 606-18 18 cm / 7"



Pozzi
GK 610-25 25,5 cm / 10"



Schröder
GK 620-25 25 cm / 10"

Hakenzangen

Tenaculum Forceps

Pinzas para cuello uterino



Braun
GK 630-25 25 cm / 10"



Littlewood
GK 640-18 18,5 cm / 7 1/4"

W
M 1/4



Beacham
Amniotom - amniotome - amniótomo
GK 650-26 26 cm / 10 1/4"



Duplay
GK 661-28 28 cm / 11"



Teale
GK 671-23 23 cm / 9"

Hakenzangen
Tenaculum Forceps
Pinzas para cuello uterino



Schröder

2 x 2 Zähne - 2 x 2 prongs - 2 x 2 dientes

gerade - straight - recta

GK 680-24 24 cm / 9½"

gebogen - curved - curva

GK 681-24 24 cm / 9½"



Czerny

4 x 4 Zähne - 4 x 4 prongs - 4 x 4 dientes

GK 690-20 20,5 cm / 8"



Braun

4 x 4 Zähne - 4 x 4 prongs - 4 x 4 dientes

GK 700-15 15,5 cm / 6"



Czerny

4 x 4 Zähne - 4 x 4 prongs - 4 x 4 dientes

GK 710-26 26 cm / 10¼"

Hakenzangen

Tenaculum Forceps

Pinzas para cuello uterino



Museux

2 x 2 Zähne - 2 x 2 teeth - 2 x 2 dientes

Breite - width - anchura 6 mm

GK 720-06 24 cm / 9½"

Breite - width - anchura 8 mm

GK 720-08 24 cm / 9½"

Breite - width - anchura 10 mm

GK 720-10 24 cm / 9½"



Jacobs

2 x 2 Zähne - 2 x 2 teeth - 2 x 2 dientes

GK 740-21 21 cm / 8¼"



Iowa

Membranperforierzange

Membrane Puncturing Forceps

Pinza para la perforación de membrana

GK 751-26 26 cm / 10¼"



Henrotin

2 x 3 Zähne - 2 x 3 teeth - 2 x 3 dientes

GK 790-20 20,5 cm / 8"

Ovarienzangen, Uteruspolypenzangen, Uterusfasszange
Ovary Forceps, Uterine grasping Forceps
Pinzas para pólipos uterinos, pinzas para cuello uterino



Kelly
gebogen - curved - curva
GK 811-32 32 cm / 12½"



Noto
GK 820-27 27 cm / 10¾"



Doyen
GK 830-18 18,5 cm / 7¼"



Dartigues
GK 840-27 27 cm / 10¾"



Somer
GK 851-23 23 cm / 9"

Uterus- Plazenta- und Abortuszangen
Uterine, Placenta and Abortion Forceps
Pinzas para aborto, placenta y útero



Collin
GK 860-25 25 cm / 10"



Winter
 gerade - straight - recta
GK 890-27 27 cm / 10¾"
GK 890-28 28 cm / 11"

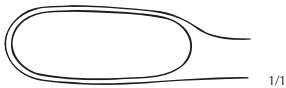

GK 890-27
GK 891-27

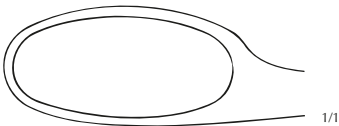

GK 890-28
GK 891-28

gebogen - curved - curva
GK 891-27 27 cm / 10¾"
GK 891-28 28 cm / 11"



Green-Armytage
GK 900-21 21 cm / 8¼"

Plazenta- und Abortuszangen
Placenta and Abortion Forceps
Pinzas para placenta y útero

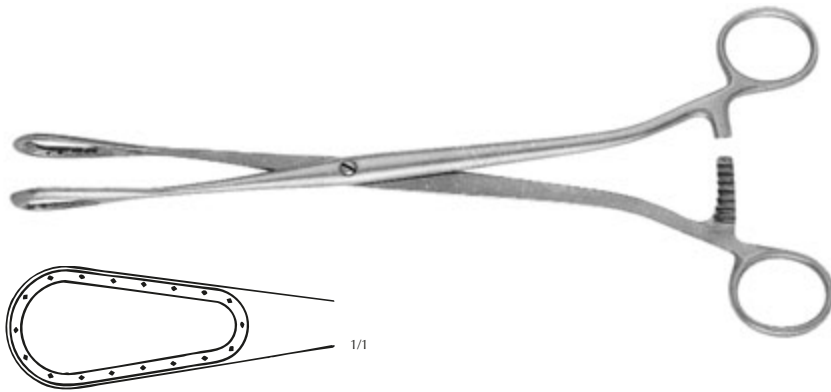

Sänger

gerade – straight – recta

GK 910-27 27 cm / 10³/₄"

gebogen – curved – curva

GK 911-27 27 cm / 10³/₄"



Mc Clintock

gebogen – curved – curva

GK 921-24 24 cm / 9¹/₂"

Myom - Instrumente, Fistelhaken

Myoma Instruments, Fistula Hooks

Instrumentos para fibroma, Ganchos para fistulas



Doyen
GK 940-17 17 cm / 6¾"



Doyen
GK 950-17 17 cm / 6¾"



Segond
 gebogen - curved - curvo
GK 961-27 27 cm / 10½"



Ayre
 aufgewinkelt - angled on flat - angulado de plano
GK 975-23 23 cm / 9"



Simon
 scharf - sharp - agudo
GK 981-01 21,5 cm / 8½"

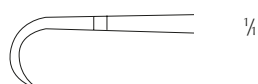

Simon
 scharf - sharp - agudo

2-zahnig - 2 prongs - 2 dientes
GK 981-02 21,5 cm / 8½"

Probeexzisionszangen, Biopsiezangen
Biopsy Forceps, Uterine Biopsy forceps
Pinzas para biopsia

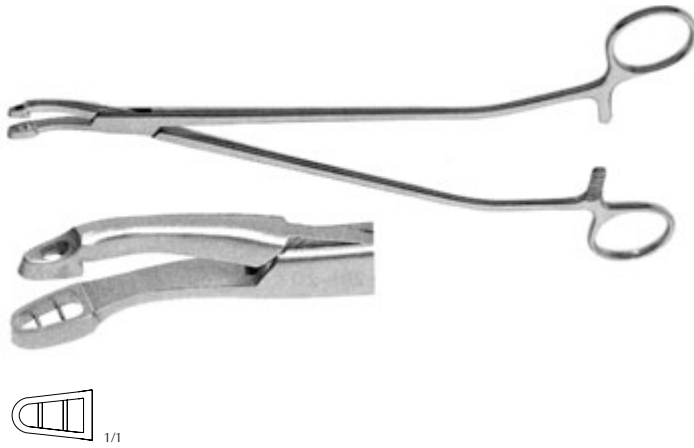

Van Doren
Rundmaul - round jaw - boca redonda
GO 121-25 25,5 cm / 10"

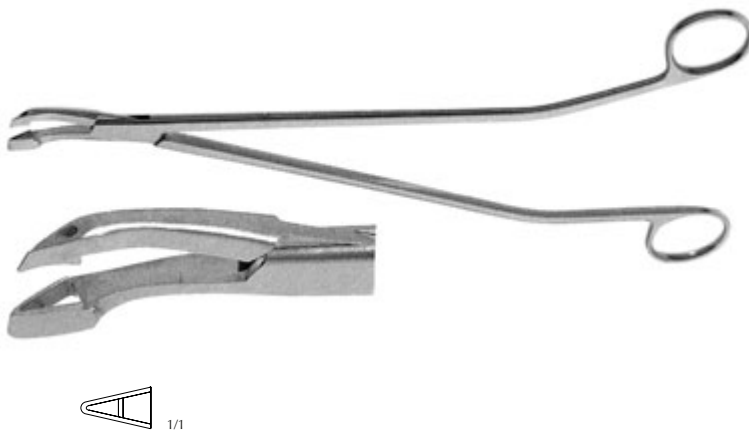

Van Doren
Dreieckmaul - triangular jaw - boca triangular
GO 131-27 27,5 cm / 10³/₄"



Thoms-Gaylor
Ø 5mm
GO 151-24 24 cm / 9¹/₂"

Biopsiezangen

Biopsy Forceps

Pinzas para biopsia

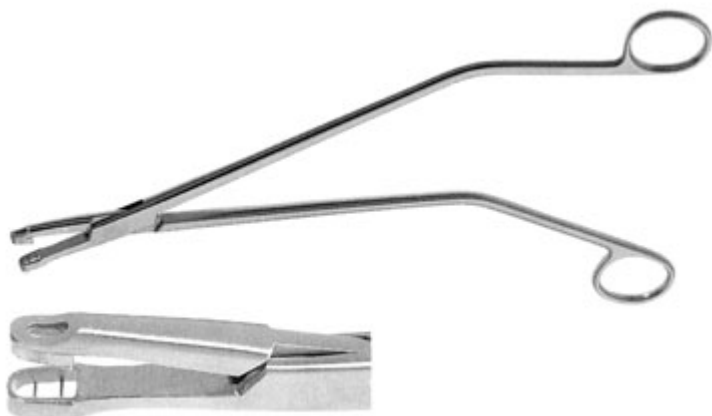

Schubert
GO 171-26 26,5 cm / 10½"

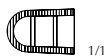

Gellhorn
GO 191-23 23 cm / 9"

Biopsiezangen
Biopsy Forceps
Pinzas para biopsia

Längenangabe = Schaftlänge

Length indication = length of shaft

Indicación de longitud = longitud de tubo

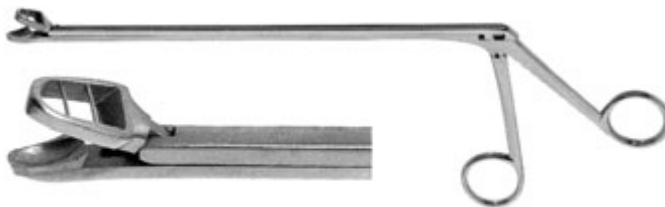

Alexander

ziehender Schnitt - pulling cut - corte tirando
GO 200-20 20 cm / 8"

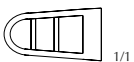

Schuhmacher

ziehender Schnitt - pulling cut - corte tirando

Breite - width - anchura 4 mm

GO 221-24 24 cm / 9½"

Breite - width - anchura 6 mm

GO 224-24 24 cm / 9½"

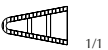

GO 221-24

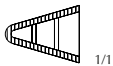

GO 224-24



Kevorkian

GO 230-24 24,5 cm / 9¾"



Biopsiezangen

Biopsy Forceps

Pinzas para biopsia

Längenangabe = Schaftlänge

Length indication = length of shaft

Indicación de longitud = longitud de tubo



Wittner

Breite - width - anchura 4 mm

gerade - straight - recta

GO 240-23 23 cm / 9"

gebogen - curved - curva

GO 241-23 23 cm / 9"



Eppendorf

GO 260-20 20 cm / 8"

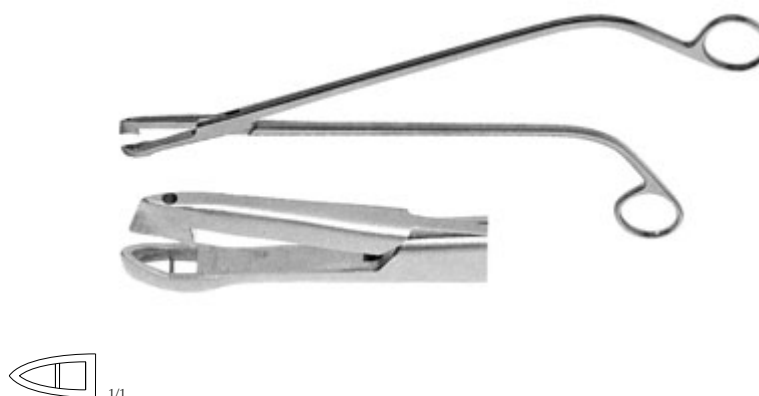

Tischler

Breite - width - anchura 4 mm

GO 274-27 27,5 cm / 10¾"

Biopsiezangen
Biopsy Forceps
Pinzas para biopsia

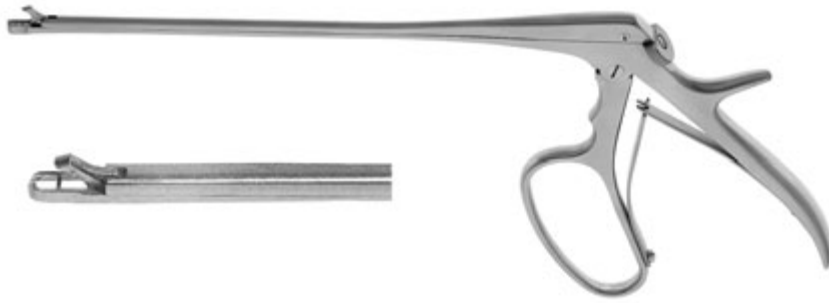

Baby-Tischler

Breite - width - anchura 2,3 mm

GO 280-20 20 cm / 8"

Breite - width - anchura 2,3 mm

GO 280-25 25 cm / 10"



Tischler

Breite - width - anchura 3 mm

GO 282-20 20 cm / 8"

Breite - width - anchura 3 mm

GO 282-23 23 cm / 9"



Berger

Schnitt Ø – cut Ø – corte Ø 5 mm

GO 290-21 21 cm / 8¼"

Artikel-Nr.	Menge quantity cantidad	Beschreibung Description descripción
-------------	-------------------------------	--

ZG 101-00

Gynäkologisches Untersuchungs-Set Gynecological Examination Set Set para Examen Ginecológico

AA 200-18	1	METZENBAUM DISS SCISSOR BL/BL STR 18CM
AL 221-26	2	BOZEMAN SPONGE FCPS S-SHAPED SERR 26CM
GD 140-01	1	CUSCO VAGINAL SPECULA 75MMX32MM
GD 160-01	1	CUSCO VAGINAL SPECULA 75MMX32MM
GD 160-02	1	CUSCO VAGINAL SPECULA 85MMX35MM
GD 220-01	1	GRAVES VAGINAL SPECULA 75MMX20MM
GD 220-02	1	GRAVES VAGINAL SPECULA 95MMX35MM
GD 220-03	1	GRAVES VAGINAL SPECULA 115MMX35MM
GD 200-01	1	PEDERSON VAGINAL SPECULA 75MMX13MM
GK 250-32	1	SIMS UTERINE PROBE STAINLESS STEEL 32CM
GK 370-02	1	NOVAK SUCTION CURETTE DIAM 2MM 25CM
GK 590-00	1	HYSTEROSALPINGOGRAPH COMPLETE
GK 620-25	1	SCHROEDER TENACULUM FORCEPS 25CM
GO 230-24	1	KEVORKIAN BIOPSY FORCEPS 24.5CM
SA 501-27	1	CHEATLE STERILISING FORCEPS 27CM

ZG 102-00

Grundset für die vaginale Chirurgie Basic Vaginal Instrument Set Set de instrumental Básico Vaginal

AA 102-14	1	SURGICAL SCISSOR SH/BL STR 14.5CM
AD 530-17	1	GOLD-CUT MAYO-STILLE SCISSOR STR 17CM
AD 531-17	1	GOLD-CUT MAYO-STILLE SCISSOR CVD 17CM
AD 551-18	1	GOLD-CUT METZENB SCISSOR BL/BL CVD 18CM
AE 100-14	2	DRESSING FORCEPS STANDARD STR 14.5CM
AE 100-20	1	DRESSING FORCEPS STANDARD STR 20CM
AE 406-14	2	TISSUE FORCEPS 1X2T STR 14.5CM
AE 406-20	1	TISSUE FORCEPS 1X2T STR 20CM
AI 333-16	6	PEAN (ROCHESTER) HEMOSTAT FCPS CVD 16CM
AI 416-16	3	KOCHER HEMOSTATIC FORCEPS 1X2T STR 16CM
AI 130-14	12	CRILE HEMOSTATIC FORCEPS STR 14CM
AK 151-13	6	BACKHAUS TOWEL FORCEPS 13CM
AL 200-25	6	FOERSTER SPONGE HOLD FCPS SERR STR 25CM
AL 221-26	1	BOZEMAN SPONGE FCPS S-SHAPED SERR 26CM
AR 200-18	1	GOLD-GRIP MAYO-HEGAR NDHL P05 18CM
AS 100-03	1	SCALPEL HANDLE NO 3 STANDARD
AS 100-04	1	SCALPEL HANDLE NO 4
AS 110-04	1	SCALPEL HANDLE NO 4L LONG
AX 610-00	1	PARKER RETRACTOR SET #1-2 14CM
AX 800-03	2	DEAVER RETRACTOR 25MM 23CM
GD 401-02	1	SIMS VAG SPECUL 70X30/70X35MM
GK 250-32	1	SIMS UTERINE PROBE STAINLESS STEEL 32CM
GK 620-25	2	SCHROEDER TENACULUM FORCEPS 25CM
MC 120-15	4	ALLIS INTESTINAL FORCEPS 5X6T 15CM

Artikel-Nr.	Menge quantity cantidad	Beschreibung Description descripción
-------------	-------------------------------	--

ZG 103-00

Instrumenten-Set für die gynäkologisch-stationäre Versorgung Gynecological Ward Treatment Set Set Ginecológica para Sala de Tratamiento

AA 102-14	1	SURGICAL SCISSOR SH/BL STR 14.5CM
AE 100-16	1	DRESSING FORCEPS STANDARD STR 16CM
AE 100-25	2	DRESSING FORCEPS STANDARD STR 25CM
AE 406-16	1	TISSUE FORCEPS 1X2T STR 16CM
AI 130-14	2	CRILE HEMOSTATIC FORCEPS STR 14CM
AL 120-25	2	GROSS-MAIER SPONGE HOLDING FCPS STR 25CM
AL 200-25	2	FOERSTER SPONGE HOLD FCPS SERR STR 25CM
AL 321-26	2	BOZEMAN-DOUGLAS SPONGE HLD FCPS CVD 26CM
AW 100-25	2	BUTTON-END PROBE DIA 1.5MM 25CM
AX 590-27	2	SIMON RETRACTOR 115X27MM 28CM
GD 140-01	2	CUSCO VAGINAL SPECULA 75MMX32MM
GD 220-01	2	GRAVES VAGINAL SPECULA 75MMX20MM
GD 220-02	4	GRAVES VAGINAL SPECULA 95MMX35MM
GD 220-03	2	GRAVES VAGINAL SPECULA 115MMX35MM
GD 420-02	1	KRISTELLER VAGINAL SPECULA STANDARD SET
GD 460-01	1	KRISTELLER VAGINAL SPECULA SET
GD 460-02	1	KRISTELLER VAGINAL SPECULA SET

ZG 104-00

Abdominal-gynäkologisches Instrumenten-Set Abdominal Gynecological Operation Set Instrumental Cirugía Ginecológica por Vía Abdominal

AA 165-16	1	KELLY SURGICAL SCISSOR CVD 16CM
AD 511-23	1	GOLD-CUT MAYO DISSECT SCISS CVD 23CM
AE 406-20	1	TISSUE FORCEPS 1X2T STR 20CM
AE 406-25	1	TISSUE FORCEPS 1X2T STR 25CM
AI 333-16	6	PEAN (ROCHESTER) HEMOSTAT FCPS CVD 16CM
AI 416-18	6	KOCHER HEMOSTATIC FORCEPS 1X2T STR 18CM
AI 713-21	4	HEANEY HYSTERECTOMY CLAMP 1X1T CVD 21CM
AL 200-25	6	FOERSTER SPONGE HOLD FCPS SERR STR 25CM
AN 321-21	2	HEANEY NEEDLE HOLDER CURVED 21CM
AX 800-09	2	DEAVER RETRACTOR 75MM 30CM
GD 700-00	1	O'SULLIVAN-O'CONNOR VAGINAL SPEC COMPL
GK 680-24	2	SCHROEDER VULSELLUM FCPS 2X2T STR 24CM
GK 681-24	2	SCHROEDER VULSELLUM FCPS 2X2T CVD 24CM
MC 120-19	6	ALLIS INTESTINAL FORCEPS 5X6T 19CM

Artikel-Nr.	Menge quantity cantidad	Beschreibung Description descripción
-------------	-------------------------------	--

ZG 106-00

Gynäkologisch-geburtshilfliches Instrumenten-Set Gynecological & Obstretical Instrument Set Instrumental Cirugía Ginecológica y Obstétrica

AA 100-14	2	SURGICAL SCISSOR BL/BL STR 14.5CM
AA 170-17	6	MAYO DISSECTING SCISSOR STR 17CM
AA 171-17	6	MAYO DISSECTING SCISSOR CVD 17CM
AD 511-23	2	GOLD-CUT MAYO DISSECT SCISS CVD 23CM
AE 100-14	12	DRESSING FORCEPS STANDARD STR 14.5CM
AE 406-14	12	TISSUE FORCEPS 1X2T STR 14.5CM
AI 090-12	12	MICRO-MOSQUITO HEMOSTATIC FCPS STR 12CM
AI 091-12	12	MICRO-MOSQUITO HEMOSTATIC FCPS CVD 12CM
AI 130-14	12	CRILE HEMOSTATIC FORCEPS STR 14CM
AI 131-14	12	CRILE HEMOSTATIC FORCEPS CVD 14CM
AI 332-16	12	PEAN (ROCHESTER) HEMOSTAT FCPS STR 16CM
AK 151-13	24	BACKHAUS TOWEL FORCEPS 13CM
AL 200-25	24	FOERSTER SPONGE HOLD FCPS SERR STR 25CM
AL 221-26	4	BOZEMAN SPONGE FCPS S-SHAPED SERR 26CM
AR 200-18	4	GOLD-GRIP MAYO-HEGAR NDHL P05 18CM
AW 110-16	2	BUTTON-END PROBE DIA 2.0MM 16CM
AZ 270-18	1	GELPI SELF-RETAINING RETRACTOR 18CM
GA 100-34	1	PELVIMETER WITHCMINCH SCALE 34CM
GD 200-01	1	PEDERSON VAGINAL SPECULA 75MMX13MM
GD 220-01	2	GRAVES VAGINAL SPECULA 75MMX20MM
GD 220-02	3	GRAVES VAGINAL SPECULA 95MMX35MM
GD 220-03	2	GRAVES VAGINAL SPECULA 115MMX35MM
GD 560-01	2	DOYEN VAGINAL SPECULA CONCAVE 55MMX45MM
GD 560-02	2	DOYEN VAGINAL SPECULA CONCAVE 85MMX45MM
GD 560-03	2	DOYEN VAGINAL SPECULA CONCAVE 115MMX45MM
GD 670-00	1	AUVARD VAGINAL SPECULA COMPL 80MMX38MM
GK 620-25	2	SCHROEDER TENACULUM FORCEPS 25CM
GK 650-26	2	BEACHAM AMNIOTOME 26CM
GK 751-26	2	IOWA MEMBRANE PUNCTURING FORCEPS 26CM
GK 811-32	1	KELLY PLACENTA FORCEPS CVD 32CM
ID 480-15	2	PINARD STETHOSCOPE 15CM
MC 120-15	12	ALLIS INTESTINAL FORCEPS 5X6T 15CM

ZG 107-00

Instrumenten-Set für die Eileiterresektion Salpingotomy Set Set Salpingectomía

AD 784-11	1	GOLD-CUT IRIS SCISSOR SH/SH STR 11.5CM
AD 785-11	1	GOLD-CUT IRIS SCISSOR SH/SH CVD 11.5CM
AE 486-12	2	ADSON TISSUE FORCEPS 1X2T STR 12CM
AI 090-12	6	MICRO-MOSQUITO HEMOSTATIC FCPS STR 12CM
AI 091-12	6	MICRO-MOSQUITO HEMOSTATIC FCPS CVD 12CM
AI 141-16	1	RANKIN-CRILE HEMOSTATIC FORCEPS CVD 16CM
AL 200-25	1	FOERSTER SPONGE HOLD FCPS SERR STR 25CM
AR 220-15	2	GOLD-GRIP CRILE-WOOD NDHL P04 15CM
AS 100-03	1	SCALPEL HANDLE NO 3 STANDARD
AW 120-14	1	BUTTON-END PROBE W EYE DIA 2.0MM 14.5CM
GD 401-02	2	SIMS VAG SPECUL 70X30/70X35MM
GK 680-24	1	SCHROEDER VULSELLUM FCPS 2X2T STR 24CM

Artikel-Nr.	Menge quantity cantidad	Beschreibung Description descripción
-------------	-------------------------------	--

ZG 108-00

Instrumenten-Set für Dilatation und Ausschabung Dilatation & Curettage Set Set para Dilatación y Curetaje

AD 530-17	1	GOLD-CUT MAYO-STILLE SCISSOR STR 17CM
AD 531-17	1	GOLD-CUT MAYO-STILLE SCISSOR CVD 17CM
AE 100-20	1	DRESSING FORCEPS STANDARD STR 20CM
AE 406-14	1	TISSUE FORCEPS 1X2T STR 14.5CM
AI 140-16	2	RANKIN-CRILE HEMOSTATIC FORCEPS STR 16CM
AI 333-16	2	PEAN (ROCHESTER) HEMOSTAT FCPS CVD 16CM
AK 151-13	4	BACKHAUS TOWEL FORCEPS 13CM
AL 200-25	4	FOERSTER SPONGE HOLD FCPS SERR STR 25CM
AL 201-18	1	FOERSTER SPONGE HOLD FCPS SERR CVD 18CM
AL 221-26	1	BOZEMAN SPONGE FCPS S-SHAPED SERR 26CM
AR 200-18	1	GOLD-GRIP MAYO-HEGAR NDHL P05 18CM
AS 100-03	1	SCALPEL HANDLE NO 3 STANDARD
GD 440-01	1	KRISTELLER VAGIN SPEC EXTRA NARROW SET
GD 442-02	2	KRISTELLER VAGINAL RETRACTOR 110X17MM
GD 670-00	1	AUVARD VAGINAL SPECULA COMPL 80MMX38MM
GK 170-00	1	HEGAR UT DIL DBL IN MET BOX 1X2-25X26MM
GK 250-32	1	SIMS UTERINE PROBE STAINLESS STEEL 32CM
GK 400-07	1	RECAMIER UTER CUR RIGID BLUNT 7MM 31CM
GK 400-09	1	RECAMIER UTER CUR RIGID BLUNT 9MM 31CM
GK 405-08	1	RECAMIER UTER CUR RIGID SHARP 8MM 31CM
GK 405-11	1	RECAMIER UTER CUR RIGID SHARP 11MM 31CM
GK 680-24	1	SCHROEDER VULSELLUM FCPS 2X2T STR 24CM
GK 681-24	2	SCHROEDER VULSELLUM FCPS 2X2T CVD 24CM

ZG 109-00

Instrumenten-Set für die Perineoplastik Perineal Plastic Set Set Plástica Perineal

AD 530-17	1	GOLD-CUT MAYO-STILLE SCISSOR STR 17CM
AD 531-17	1	GOLD-CUT MAYO-STILLE SCISSOR CVD 17CM
AE 100-14	2	DRESSING FORCEPS STANDARD STR 14.5CM
AE 100-20	1	DRESSING FORCEPS STANDARD STR 20CM
AE 406-14	1	TISSUE FORCEPS 1X2T STR 14.5CM
AE 406-16	1	TISSUE FORCEPS 1X2T STR 16CM
AI 130-14	12	CRILE HEMOSTATIC FORCEPS STR 14CM
AI 140-16	2	RANKIN-CRILE HEMOSTATIC FORCEPS STR 16CM
AI 333-16	2	PEAN (ROCHESTER) HEMOSTAT FCPS CVD 16CM
AI 333-24	6	PEAN (ROCHESTER) HEMOSTAT FCPS CVD 24CM
AI 416-16	6	KOCHER HEMOSTATIC FORCEPS 1X2T STR 16CM
AK 151-13	4	BACKHAUS TOWEL FORCEPS 13CM
AL 200-25	4	FOERSTER SPONGE HOLD FCPS SERR STR 25CM
AL 201-18	1	FOERSTER SPONGE HOLD FCPS SERR CVD 18CM
AL 221-26	1	BOZEMAN SPONGE FCPS S-SHAPED SERR 26CM
AR 200-18	1	GOLD-GRIP MAYO-HEGAR NDHL P05 18CM
AS 100-03	1	SCALPEL HANDLE NO 3 STANDARD
AW 110-14	1	BUTTON-END PROBE DIA 2.0MM 14.5CM
AW 150-14	1	GROOVED DIRECTOR 14.5CM
AZ 270-18	1	GELPI SELF-RETAINING RETRACTOR 18CM
GD 440-01	1	KRISTELLER VAGIN SPEC EXTRA NARROW SET
GD 442-02	2	KRISTELLER VAGINAL RETRACTOR 110X17MM

Artikel-Nr.	Menge quantity cantidad	Beschreibung Description descripción
GD 670-00	1	AUVARD VAGINAL SPECULA COMPL 80MMX38MM
GK 170-00	1	HEGAR UT DIL DBL IN MET BOX 1X2-25X26MM
GK 250-32	1	SIMS UTERINE PROBE STAINLESS STEEL 32CM
GK 400-07	1	RECAMIER UTER CUR RIGID BLUNT 7MM 31CM
GK 400-09	1	RECAMIER UTER CUR RIGID BLUNT 9MM 31CM
GK 405-08	1	RECAMIER UTER CUR RIGID SHARP 8MM 31CM
GK 405-11	1	RECAMIER UTER CUR RIGID SHARP 11MM 31CM
GK 680-24	1	SCHROEDER VULSELLUM FCPS 2X2T STR 24CM
GK 681-24	2	SCHROEDER VULSELLUM FCPS 2X2T CVD 24CM
MC 120-19	6	ALLIS INTESTINAL FORCEPS 5X6T 19CM

ZG 110-00

Instrumenten-Set für die vaginale Hysterektomie Vaginal Hysterectomy Set Set Histerectomía Vaginal

AA 102-14	1	SURGICAL SCISSOR SH/BL STR 14.5CM
AD 530-17	1	GOLD-CUT MAYO-STILLE SCISSOR STR 17CM
AD 531-17	1	GOLD-CUT MAYO-STILLE SCISSOR CVD 17CM
AD 551-18	1	GOLD-CUT METZENB SCISSOR BL/BL CVD 18CM
AD 551-20	1	GOLD-CUT METZENB SCISSOR BL/BL CVD 20CM
AD 810-12	1	GOLD-CUT UNIVER WIRE CUT SCS SERR 12,5CM
AE 100-14	2	DRESSING FORCEPS STANDARD STR 14.5CM
AE 100-20	1	DRESSING FORCEPS STANDARD STR 20CM
AE 406-14	2	TISSUE FORCEPS 1X2T STR 14.5CM
AE 406-20	1	TISSUE FORCEPS 1X2T STR 20CM
AI 100-12	12	HALSTEAD-MOSQUITO HEMOST FCPS STR 12.5CM
AI 101-12	12	HALSTEAD-MOSQUITO HEMOST FCPS CVD 12.5CM
AI 140-16	6	RANKIN-CRILE HEMOSTATIC FORCEPS STR 16CM
AI 141-16	6	RANKIN-CRILE HEMOSTATIC FORCEPS CVD 16CM
AI 333-16	12	PEAN (ROCHESTER) HEMOSTAT FCPS CVD 16CM
AI 333-18	6	PEAN (ROCHESTER) HEMOSTAT FCPS CVD 18CM
AI 416-16	6	KOCHER HEMOSTATIC FORCEPS 1X2T STR 16CM
AI 713-21	6	HEANEY HYSTERECTOMY CLAMP 1X1T CVD 21CM
AK 151-13	12	BACKHAUS TOWEL FORCEPS 13CM
AL 200-25	6	FOERSTER SPONGE HOLD FCPS SERR STR 25CM
AN 510-21	1	DESCHAMPS LIGAT NEEDLE RIGHT CVD BL 21CM
AN 511-21	1	DESCHAMPS LIGAT NEEDLE LEFT CVD BL 21CM
AR 200-16	1	GOLD-GRIP MAYO-HEGAR NDHL P05 16CM
AR 200-18	1	GOLD-GRIP MAYO-HEGAR NDHL P05 18CM
AR 200-20	1	GOLD-GRIP MAYO-HEGAR NDHL P05 20CM
AS 100-03	1	SCALPEL HANDLE NO 3 STANDARD
AS 100-04	1	SCALPEL HANDLE NO 4
AS 100-07	1	SCALPEL HANDLE NO 7
AT 200-00	1	YANKAUER SUCTION TUBE COMPLETE 27CM
AW 120-13	1	BUTTON-END PROBE W EYE DIA 2.0MM 13CM
AW 150-14	1	GROOVED DIRECTOR 14.5CM
AX 240-10	2	CUSHING RETRACTOR 10MM 20CM
AX 320-04	2	VOLKMANN RETRACTOR 4 PRONGS BLUNT 21.5CM
AX 320-06	2	VOLKMANN RETRACTOR 6 PRONGS BLUNT 21.5CM
AX 630-00	1	PARKER-LANGENBECK RETRACT SET #1-2 21CM
AX 680-01	2	RICHARDSON RETRACTOR 25X20MM 24CM
AX 680-02	2	RICHARDSON RETRACTOR 30X27MM 24CM
AX 680-03	2	RICHARDSON RETRACTOR 38X38MM 24CM
AX 800-08	2	DEAVER RETRACTOR 50MM 30CM
AX 910-30	1	ABDOMINAL SPATULA MALLEABLE 30MM 33CM
AX 910-40	2	ABDOMINAL SPATULA MALLEABLE 40MM 33CM

Artikel-Nr.	Menge quantity cantidad	Beschreibung Description descripción
AZ 490-00	1	BALFOUR ABDOMINAL RETRACTOR COMPLETE
GK 680-24	2	SCHROEDER VULSELLUM FCPS 2X2T STR 24CM
MC 120-15	6	ALLIS INTESTINAL FORCEPS 5X6T 15CM
MC 350-16	2	BABCOCK ATRAUMAT INTESTINAL FORCEPS 16CM

ZG 111-00

Instrumenten-Set für die abdominale Hysterektomie Abdominal Hysterectomy Set Set Histerectomía Abdominal

AA 170-17	1	MAYO DISSECTING SCISSOR STR 17CM
AA 171-17	1	MAYO DISSECTING SCISSOR CVD 17CM
AA 201-23	1	METZENBAUM DISS SCISSOR BL/BL CVD 23CM
AD 511-23	2	GOLD-CUT MAYO DISSECT SCISS CVD 23CM
AE 100-20	1	DRESSING FORCEPS STANDARD STR 20CM
AE 406-20	1	TISSUE FORCEPS 1X2T STR 20CM
AE 406-25	1	TISSUE FORCEPS 1X2T STR 25CM
AE 806-20	1	RUSSIAN GRASPING FORCEPS STR 20CM
AI 330-14	2	PEAN HEMOSTATIC FORCEPS FINE STR 14CM
AI 332-14	12	PEAN (ROCHESTER) HEMOSTAT FCPS STR 14CM
AI 332-24	6	PEAN (ROCHESTER) HEMOSTAT FCPS STR 24CM
AI 332-24	6	PEAN (ROCHESTER) HEMOSTAT FCPS STR 24CM
AI 333-20	6	PEAN (ROCHESTER) HEMOSTAT FCPS CVD 20CM
AI 416-20	4	KOCHER HEMOSTATIC FORCEPS 1X2T STR 20CM
AI 416-24	6	KOCHER HEMOSTATIC FORCEPS 1X2T STR 24CM
AI 417-20	6	KOCHER HEMOSTATIC FORCEPS 1X2T CVD 20CM
AI 417-24	6	KOCHER HEMOSTATIC FORCEPS 1X2T CVD 24CM
AI 406-14	12	KOCHER HEMOSTAT FCPS FINE 1X2T STR 14CM
AI 097-10	1	MICRO-MOSQUITO HEMOST FCPS 1X2T CVD 10CM
AK 151-13	6	BACKHAUS TOWEL FORCEPS 13CM
AN 300-20	1	MAYO-HEGAR NEEDLE HOLDER 20CM
AW 100-14	1	BUTTON-END PROBE DIA 1.5MM 14.5CM
AW 150-14	1	GROOVED DIRECTOR 14.5CM
AX 590-27	2	SIMON RETRACTOR 115X27MM 28CM
AX 665-00	1	FARABEUF RETRACTOR SET #1-2 12CM
AX 910-30	2	ABDOMINAL SPATULA MALLEABLE 30MM 33CM
AX 900-28	1	REVERDIN ABDOMINAL SPATULA 45X60MM 28CM
AZ 340-00	1	RICARD ABDOMINAL RETRACTOR
GK 630-25	1	BRAUN TENACULUM FORCEPS 25CM
GK 681-24	1	SCHROEDER VULSELLUM FCPS 2X2T CVD 24CM
GK 840-27	1	DARTIGUES UTER ELEV FCPS 27CM
GK 851-23	1	SOMER UTERINE GRASPING FORCEPS 23CM
MC 120-19	8	ALLIS INTESTINAL FORCEPS 5X6T 19CM
MC 300-18	2	BABCOCK INTESTINAL TISSUE HOLD FCPS 18CM
MC 410-20	2	COLLIN-DUVAL INTESTINAL FCPS 15MM 20CM

Artikel-Nr.	Menge quantity cantidad	Beschreibung Description descripción
-------------	-------------------------------	--

ZG 112-00

Zervix Biopsie-Set Cervix Biopsy Set Set de Biopsia Cervix

AD 530-17	1	GOLD-CUT MAYO-STILLE SCISSOR STR 17CM
AD 531-17	1	GOLD-CUT MAYO-STILLE SCISSOR CVD 17CM
AE 100-20	1	DRESSING FORCEPS STANDARD STR 20CM
AE 406-14	1	TISSUE FORCEPS 1X2T STR 14.5CM
AE 406-20	1	TISSUE FORCEPS 1X2T STR 20CM
AI 140-16	2	RANKIN-CRILE HEMOSTATIC FORCEPS STR 16CM
AI 333-16	2	PEAN (ROCHESTER) HEMOSTAT FCPS CVD 16CM
AI 333-18	2	PEAN (ROCHESTER) HEMOSTAT FCPS CVD 18CM
AK 151-13	4	BACKHAUS TOWEL FORCEPS 13CM
AL 200-25	4	FOERSTER SPONGE HOLD FCPS SERR STR 25CM
AL 201-18	1	FOERSTER SPONGE HOLD FCPS SERR CVD 18CM
AL 221-26	1	BOZEMAN SPONGE FCPS S-SHAPED SERR 26CM
AR 200-18	1	GOLD-GRIP MAYO-HEGAR NDHL P05 18CM
AS 100-03	1	SCALPEL HANDLE NO 3 STANDARD
AS 110-03	1	SCALPEL HANDLE NO 3L LONG
GD 440-01	1	KRISTELLER VAGIN SPEC EXTRA NARROW SET
GD 442-02	2	KRISTELLER VAGINAL RETRACTOR 110X17MM
GD 670-00	1	AUVARD VAGINAL SPECULA COMPL 80MMX38MM
GK 170-00	1	HEGAR UT DIL DBL IN MET BOX 1X2-25X26MM
GK 250-32	1	SIMS UTERINE PROBE STAINLESS STEEL 32CM
GK 400-07	1	RECAMIER UTER CUR RIGID BLUNT 7MM 31CM
GK 400-09	1	RECAMIER UTER CUR RIGID BLUNT 9MM 31CM
GK 405-08	1	RECAMIER UTER CUR RIGID SHARP 8MM 31CM
GK 405-11	1	RECAMIER UTER CUR RIGID SHARP 11MM 31CM
GK 680-24	1	SCHROEDER VULSELLUM FCPS 2X2T STR 24CM
GK 681-24	2	SCHROEDER VULSELLUM FCPS 2X2T CVD 24CM
GO 282-25	1	TISCHLER BIOPSY FORCEPS 4MM 25CM

ZG 113-00

Instrumenten-Set für die zervikale Kauterisation Cervix Cauterization Set Set Cauterización Cervix

AK 151-13	4	BACKHAUS TOWEL FORCEPS 13CM
AL 321-26	1	BOZEMAN-DOUGLAS SPONGE HLD FCPS CVD 26CM
AL 200-25	2	FOERSTER SPONGE HOLD FCPS SERR STR 25CM
GD 401-01	1	SIMS VAG SPECUL 65X25/70X30MM
GD 401-02	1	SIMS VAG SPECUL 70X30/70X35MM
GD 401-03	1	SIMS VAG SPECUL 85X35/90X40MM
GD 670-00	1	AUVARD VAGINAL SPECULA COMPL 80MMX38MM

Artikel-Nr.	Menge quantity cantidad	Beschreibung Description descripción
-------------	-------------------------------	--

ZG 114-00

Großes Instrumenten-Set für die vaginale Chirurgie Major Vaginal Repair Set Set Reparación Vaginal Mayor

AA 102-14	1	SURGICAL SCISSOR SH/BL STR 14.5CM
AA 165-16	1	KELLY SURGICAL SCISSOR CVD 16CM
AD 530-17	1	GOLD-CUT MAYO-STILLE SCISSOR STR 17CM
AD 531-17	1	GOLD-CUT MAYO-STILLE SCISSOR CVD 17CM
AD 551-18	1	GOLD-CUT METZENB SCISSOR BL/BL CVD 18CM
AE 100-14	2	DRESSING FORCEPS STANDARD STR 14.5CM
AE 100-20	1	DRESSING FORCEPS STANDARD STR 20CM
AE 406-14	2	TISSUE FORCEPS 1X2T STR 14.5CM
AE 406-20	1	TISSUE FORCEPS 1X2T STR 20CM
AE 806-20	1	RUSSIAN GRASPING FORCEPS STR 20CM
AI 130-14	12	CRILE HEMOSTATIC FORCEPS STR 14CM
AI 131-14	6	CRILE HEMOSTATIC FORCEPS CVD 14CM
AI 333-16	6	PEAN (ROCHESTER) HEMOSTAT FCPS CVD 16CM
AI 416-16	3	KOCHER HEMOSTATIC FORCEPS 1X2T STR 16CM
AK 151-13	6	BACKHAUS TOWEL FORCEPS 13CM
AL 200-25	6	FOERSTER SPONGE HOLD FCPS SERR STR 25CM
AL 221-26	1	BOZEMAN SPONGE FCPS S-SHAPED SERR 26CM
AR 200-18	1	GOLD-GRIP MAYO-HEGAR NDHL P05 18CM
AR 220-15	2	GOLD-GRIP CRILE-WOOD NDHL P04 15CM
AS 100-03	1	SCALPEL HANDLE NO 3 STANDARD
AS 100-04	1	SCALPEL HANDLE NO 4
AS 110-04	1	SCALPEL HANDLE NO 4L LONG
AX 610-00	1	PARKER RETRACTOR SET #1-2 14CM
AX 680-03	2	RICHARDSON RETRACTOR 38X38MM 24CM
AX 800-03	2	DEAVER RETRACTOR 25MM 23CM
GD 401-02	1	SIMS VAG SPECUL 70X30/70X35MM
GD 670-00	1	AUVARD VAGINAL SPECULA COMPL 80MMX38MM
GD 700-00	1	O'SULLIVAN-O'CONNOR VAGINAL SPEC COMPL
GK 250-32	1	SIMS UTERINE PROBE STAINLESS STEEL 32CM
GK 620-25	2	SCHROEDER TENACULUM FORCEPS 25CM
GK 680-24	2	SCHROEDER VULSELLUM FCPS 2X2T STR 24CM
MC 120-15	4	ALLIS INTESTINAL FORCEPS 5X6T 15CM
MC 180-15	2	JUDD-ALLIS TISSUE HOLDING FCPS 3X4T 15CM

ZG 115-00

Instrumenten-Set für die Geburtshilfe Obstetrical Instrument Set Set Instrumental Obstétrico

AA 102-14	1	SURGICAL SCISSOR SH/BL STR 14.5CM
AB 670-10	1	UMBILICAL SCISSOR USA PATTERN 10.5CM
AB 657-22	1	BRAUN-STADLER EPISIOTOMY SCISSOR 22CM
AI 130-14	6	CRILE HEMOSTATIC FORCEPS STR 14CM
AK 151-13	6	BACKHAUS TOWEL FORCEPS 13CM
AL 221-26	1	BOZEMAN SPONGE FCPS S-SHAPED SERR 26CM
AL 200-25	6	FOERSTER SPONGE HOLD FCPS SERR STR 25CM
AE 100-14	2	DRESSING FORCEPS STANDARD STR 14.5CM
AE 406-14	2	TISSUE FORCEPS 1X2T STR 14.5CM
AR 200-16	1	GOLD-GRIP MAYO-HEGAR NDHL P05 16CM
AR 200-18	1	GOLD-GRIP MAYO-HEGAR NDHL P05 18CM
GA 100-34	1	PELVIMETER WITHCM/INCH SCALE 34CM

Artikel-Nr.	Menge quantity cantidad	Beschreibung Description descripción
GA 260-36	1	SIMPSON-BRAUN OBSTETRICAL FORCEPS 36CM
GA 320-41	1	KIELLAND OBSTETRICAL FORCEPS 41CM
GA 450-44	1	PIPER OBSTETRICAL FORCEPS 44CM
GA 490-20	1	BILL TRACTION HANDLE F OBSTET FCPS 20CM
GK 620-25	2	SCHROEDER TENACULUM FORCEPS 25CM
GK 751-26	1	IOWA MEMBRANE PUNCTURING FORCEPS 26CM
GK 911-27	1	SAENGER OVARY FORCEPS CVD 27CM
MC 120-15	6	ALLIS INTESTINAL FORCEPS 5X6T 15CM

ZG 116-00

Instrumenten-Set für die normale Entbindung Normal Delivery Set Set de Parto Normal

AA 102-14	1	SURGICAL SCISSOR SH/BL STR 14.5CM
AD 510-17	1	GOLD-CUT MAYO DISSECT SCISS STR 17CM
AE 406-14	1	TISSUE FORCEPS 1X2T STR 14.5CM
AE 806-15	1	RUSSIAN GRASPING FORCEPS STR 15CM
AI 130-14	2	CRILE HEMOSTATIC FORCEPS STR 14CM
AI 131-14	2	CRILE HEMOSTATIC FORCEPS CVD 14CM
AI 332-16	1	PEAN (ROCHESTER) HEMOSTAT FCPS STR 16CM
AI 333-16	2	PEAN (ROCHESTER) HEMOSTAT FCPS CVD 16CM
AK 151-13	4	BACKHAUS TOWEL FORCEPS 13CM
AL 200-25	2	FOERSTER SPONGE HOLD FCPS SERR STR 25CM
AR 200-18	1	GOLD-GRIP MAYO-HEGAR NDHL P05 18CM
AR 200-20	1	GOLD-GRIP MAYO-HEGAR NDHL P05 20CM
AX 700-25	1	DOYEN RETRACTOR 85X40MM 25CM
AZ 270-18	1	GELPI SELF-RETAINING RETRACTOR 18CM
GA 290-36	1	SIMPSON-LUIKART OBSTETRICAL FORCEPS 36CM
GA 350-40	2	KIELLAND-LUIKART OBSTETRICAL FORCEPS 40C
GA 450-44	1	PIPER OBSTETRICAL FORCEPS 44CM
GA 490-20	1	BILL TRACTION HANDLE F OBSTET FCPS 20CM
MC 120-15	4	ALLIS INTESTINAL FORCEPS 5X6T 15CM

ZG 117-00

Instrumenten-Set für die Versorgung von Dammverletzungen Episiotomy & Laceration Repair Set Set Reparación de Episiotomía y Laceración

AA 102-14	1	SURGICAL SCISSOR SH/BL STR 14.5CM
AD 510-14	1	GOLD-CUT MAYO DISSECT SCISS STR 14.5CM
AD 601-14	1	GOLD-CUT METZENBAUM SCISSOR CVD 14.5CM
AE 100-14	1	DRESSING FORCEPS STANDARD STR 14.5CM
AE 406-14	1	TISSUE FORCEPS 1X2T STR 14.5CM
AI 140-16	4	RANKIN-CRILE HEMOSTATIC FORCEPS STR 16CM
AI 090-12	2	MICRO-MOSQUITO HEMOSTATIC FCPS STR 12CM
AK 151-13	2	BACKHAUS TOWEL FORCEPS 13CM
AL 200-25	6	FOERSTER SPONGE HOLD FCPS SERR STR 25CM
AR 200-18	1	GOLD-GRIP MAYO-HEGAR NDHL P05 18CM
AX 680-02	1	RICHARDSON RETRACTOR 30X27MM 24CM
AZ 270-18	1	GELPI SELF-RETAINING RETRACTOR 18CM
GD 401-02	1	SIMS VAG SPECUL 70X30/70X35MM
GD 401-03	1	SIMS VAG SPECUL 85X35/90X40MM
MC 120-15	2	ALLIS INTESTINAL FORCEPS 5X6T 15CM

Artikel-Nr.	Menge quantity cantidad	Beschreibung Description descripción
-------------	-------------------------------	--

ZG 118-00

Instrumenten-Set für den Kaiserschnitt Caesarian Section Set Set Instrumental Cesárea

AA 102-14	1	SURGICAL SCISSOR SH/BL STR 14.5CM
AD 511-23	1	GOLD-CUT MAYO DISSECT SCISS CVD 23CM
AD 530-17	1	GOLD-CUT MAYO-STILLE SCISSOR STR 17CM
AD 531-17	1	GOLD-CUT MAYO-STILLE SCISSOR CVD 17CM
AD 551-18	1	GOLD-CUT METZENB SCISSOR BL/BL CVD 18CM
AD 810-12	1	GOLD-CUT UNIVER WIRE CUT SCS SERR 12,5CM
AE 100-14	2	DRESSING FORCEPS STANDARD STR 14.5CM
AE 100-20	1	DRESSING FORCEPS STANDARD STR 20CM
AE 406-14	2	TISSUE FORCEPS 1X2T STR 14.5CM
AE 406-20	1	TISSUE FORCEPS 1X2T STR 20CM
AI 100-12	12	HALSTEAD-MOSQUITO HEMOST FCPS STR 12.5CM
AI 101-12	12	HALSTEAD-MOSQUITO HEMOST FCPS CVD 12.5CM
AI 140-16	6	RANKIN-CRILE HEMOSTATIC FORCEPS STR 16CM
AI 141-16	6	RANKIN-CRILE HEMOSTATIC FORCEPS CVD 16CM
AI 333-16	2	PEAN (ROCHESTER) HEMOSTAT FCPS CVD 16CM
AI 416-16	6	KOCHER HEMOSTATIC FORCEPS 1X2T STR 16CM
AK 151-13	12	BACKHAUS TOWEL FORCEPS 13CM
AL 200-25	6	FOERSTER SPONGE HOLD FCPS SERR STR 25CM
AN 510-21	1	DESCHAMPS LIGAT NEEDLE RIGHT CVD BL 21CM
AN 511-21	1	DESCHAMPS LIGAT NEEDLE LEFT CVD BL 21CM
AR 200-16	1	GOLD-GRIP MAYO-HEGAR NDHL P05 16CM
AR 200-18	1	GOLD-GRIP MAYO-HEGAR NDHL P05 18CM
AR 200-20	2	GOLD-GRIP MAYO-HEGAR NDHL P05 20CM
AR 200-26	1	GOLD-GRIP MAYO-HEGAR NDHL P05 26CM
AS 100-03	1	SCALPEL HANDLE NO 3 STANDARD
AS 100-04	1	SCALPEL HANDLE NO 4
AS 100-07	1	SCALPEL HANDLE NO 7
AS 110-03	1	SCALPEL HANDLE NO 3L LONG
AT 200-00	1	YANKAUER SUCTION TUBE COMPLETE 27CM
AW 120-13	1	BUTTON-END PROBE W EYE DIA 2.0MM 13CM
AW 150-14	1	GROOVED DIRECTOR 14.5CM
AX 240-10	2	CUSHING RETRACTOR 10MM 20CM
AX 320-04	2	VOLKMANN RETRACTOR 4 PRONGS BLUNT 21.5CM
AX 320-06	2	VOLKMANN RETRACTOR 6 PRONGS BLUNT 21.5CM
AX 630-00	1	PARKER-LANGENBECK RETRACT SET #1-2 21CM
AX 680-01	2	RICHARDSON RETRACTOR 25X20MM 24CM
AX 680-02	2	RICHARDSON RETRACTOR 30X27MM 24CM
AX 680-03	2	RICHARDSON RETRACTOR 38X38MM 24CM
AX 700-25	1	DOYEN RETRACTOR 85X40MM 25CM
AX 800-08	2	DEAVER RETRACTOR 50MM 30CM
AX 910-30	1	ABDOMINAL SPATULA MALLEABLE 30MM 33CM
AX 910-40	2	ABDOMINAL SPATULA MALLEABLE 40MM 33CM
AZ 490-00	1	BALFOUR ABDOMINAL RETRACTOR COMPLETE
GA 480-26	1	MURLESS HEAD EXTRACTOR 26CM
MC 120-15	6	ALLIS INTESTINAL FORCEPS 5X6T 15CM
MC 120-19	12	ALLIS INTESTINAL FORCEPS 5X6T 19CM
MC 350-16	2	BABCOCK ATRAUMAT INTESTINAL FORCEPS 16CM

Artikel-Nr.	Menge quantity cantidad	Beschreibung Description descripción
-------------	-------------------------------	--

ZG 119-00

Instrumenten-Set für die uterine Evakuation

Uterinal Evacuation Set

Set Evacuación Uterina

AK 151-13	4	BACKHAUS TOWEL FORCEPS 13CM
AL 200-25	2	FOERSTER SPONGE HOLD FCPS SERR STR 25CM
AL 201-18	1	FOERSTER SPONGE HOLD FCPS SERR CVD 18CM
GD 670-00	1	AUVARD VAGINAL SPECULA COMPL 80MMX38MM
GK 680-24	3	SCHROEDER VULSELLUM FCPS 2X2T STR 24CM
GK 400-12	1	RECAMIER UTER CUR RIGID BLUNT 12MM 31CM
GK 400-14	1	RECAMIER UTER CUR RIGID BLUNT 14MM 31CM

ZG 121-00

Hysterosalpinographie-Set

Hysterosalpinography Set

Set Histerosalpingografía

AK 151-13	5	BACKHAUS TOWEL FORCEPS 13CM
AL 200-25	1	FOERSTER SPONGE HOLD FCPS SERR STR 25CM
AL 221-26	2	BOZEMAN SPONGE FCPS S-SHAPED SERR 26CM
GD 140-01	1	CUSCO VAGINAL SPECULA 75MMX32MM
GD 220-02	1	GRAVES VAGINAL SPECULA 95MMX35MM
GD 670-00	1	AUVARD VAGINAL SPECULA COMPL 80MMX38MM
GK 120-00	1	HEGAR UTER DILAT SET 4-17MM IN METAL
GK 250-32	1	SIMS UTERINE PROBE STAINLESS STEEL 32CM
GK 340-25	1	RANDALL SUCTION CURETTE DIAM 4MM 25CM
GK 590-00	1	HYSTEOSALPINGOGRAPH COMPLETE
GK 680-24	2	SCHROEDER VULSELLUM FCPS 2X2T STR 24CM

Artikel-Nr.	Menge quantity cantidad	Beschreibung Description descripción
-------------	-------------------------------	--

